



FINNISH SAUNA JFP220

Specifications and assembly instructions

SPECIFICATIONS



Model	JFP220
Dimensions	2200x1800x2000 mm
Number of persons	6
Wood	Finnish pine, 48 mm
Glass	Transparent, tempered, 8 mm
Hinges	Stainless Steel
Control	Touch control panel
Operating time	Up to 90 min
Temperature	Up to 90 °C
Ventilation	Yes
Connectivity	Bluetooth, Radio, App
Lighting	LED RGB starry sky
Oven	6 kW, with thermostat, timer and volcanic stone
Connection	Three-phase 400 V, 50 Hz, conductor 5 x 2,5 mm ² and 3 x 16 A fuse
Weight	295 kg

COMPONENTS

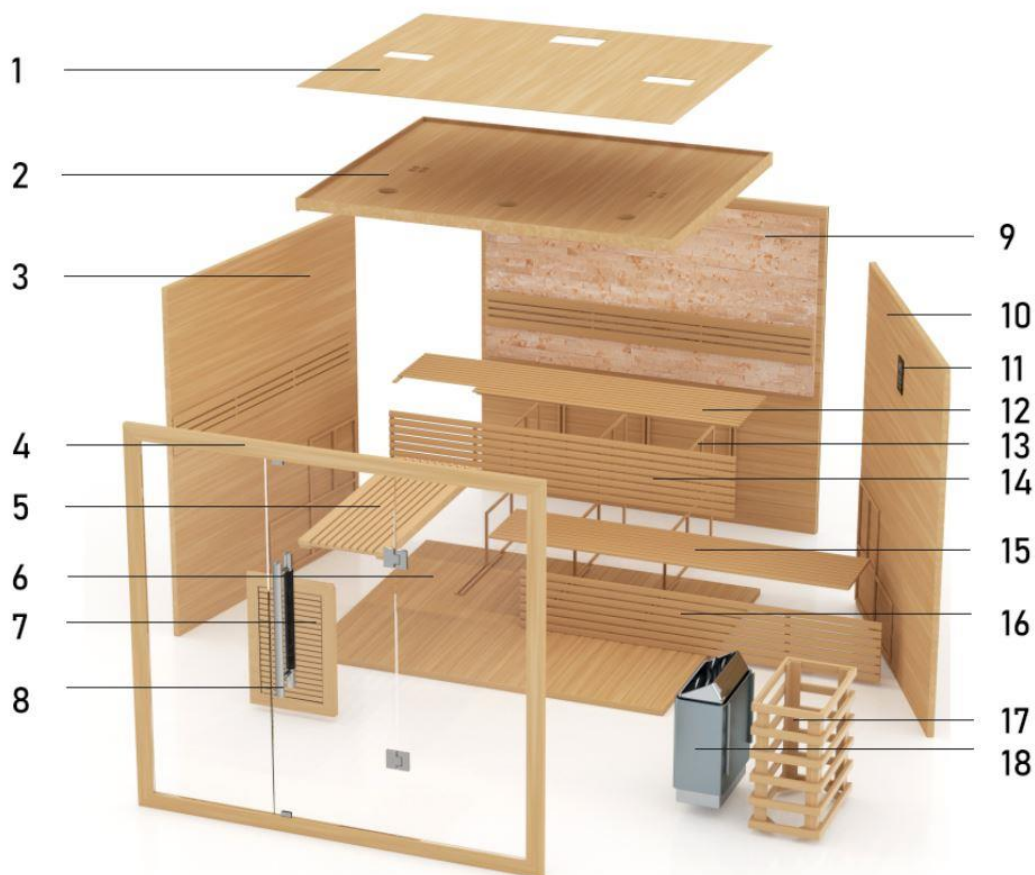

- | | |
|---------------------------------|----------------------------------|
| 1 Cover plate | 10 Right side |
| 2 Ceiling panel | 11 Control panel |
| 3 Left side | 12 Upper bench |
| 4 Front panel with glass | 13 Bench holders |
| 5 Left upper bench | 14 Front side of the upper bench |
| 6 Bottom plate | 15 Lower bench |
| 7 Bench side | 16 Front side of the lower bench |
| 8 Front side of the lower bench | 17 Stove frame |
| 9 Backplate | 18 Stove |

RECOMMENDED TOOLS

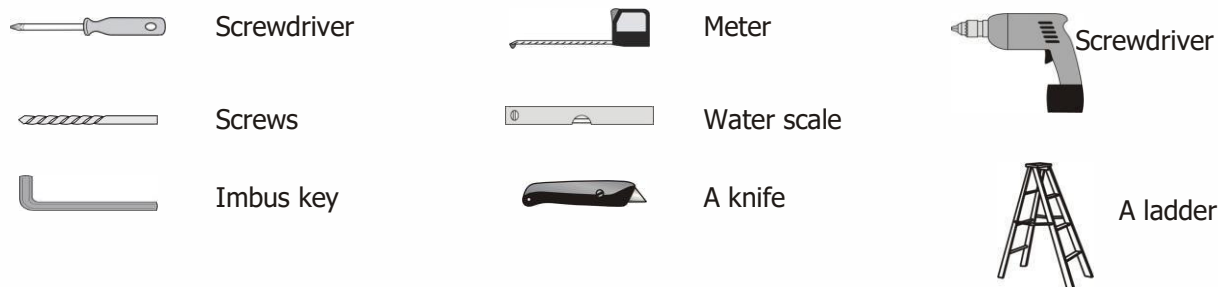

ASSEMBLY TIPS

Please remove the transport packaging and check that your sauna has been delivered complete and undamaged before starting assembly. At least two people are needed to assemble the sauna.



ASSEMBLY STEPS



1. Back plate



2. Right side



3. Left side



4. Bottom



5. Bench holders



6. The front side of the lower bench



7. Bench



8. The front side of the upper bench



9. Upper bench





10. Bench side



11. Left upper bench



12. Front panel with glass
*check instructions below



13. Handle



14. Ceiling plate

*after installing the ceiling,
connect the electrical components
as described in the paragraph
"Connecting the electrical
components"



15. Cover plate



16 Stove frame and stove

Composition of the front side with glasses



1. Carefully place the side glasses on the raised base and insert the lower and upper part of the frame.



2. Move the glass over the edge so that it looks about 1 cm out from the bottom and top of the frame. Insert the side parts of the frame.

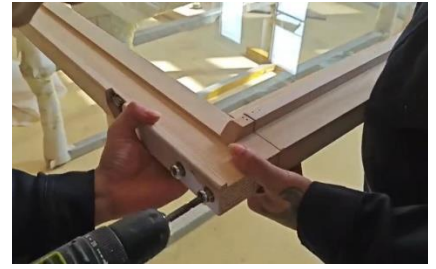

3. Fasten the side parts of the frame with the supplied screws.



4. Lift the side, insert it into the front of the sauna and fasten it with the buckles.



5. Screw the metal part to connect the frame parts to the upper side of the frame.



6. Install the hinges and glass door of the sauna.

Installing the outer buckle

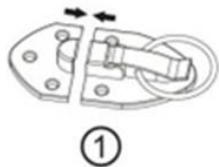

①



②

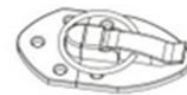

③

Connecting electrical components



1. Connect the blue UTP cable from the control panel to the sauna control unit.



2. Connect the power cables between the control unit and the stove.



1. Connect the starry sky cables and connect the other cables (control panel and speakers)

CONNECTION SCHEME

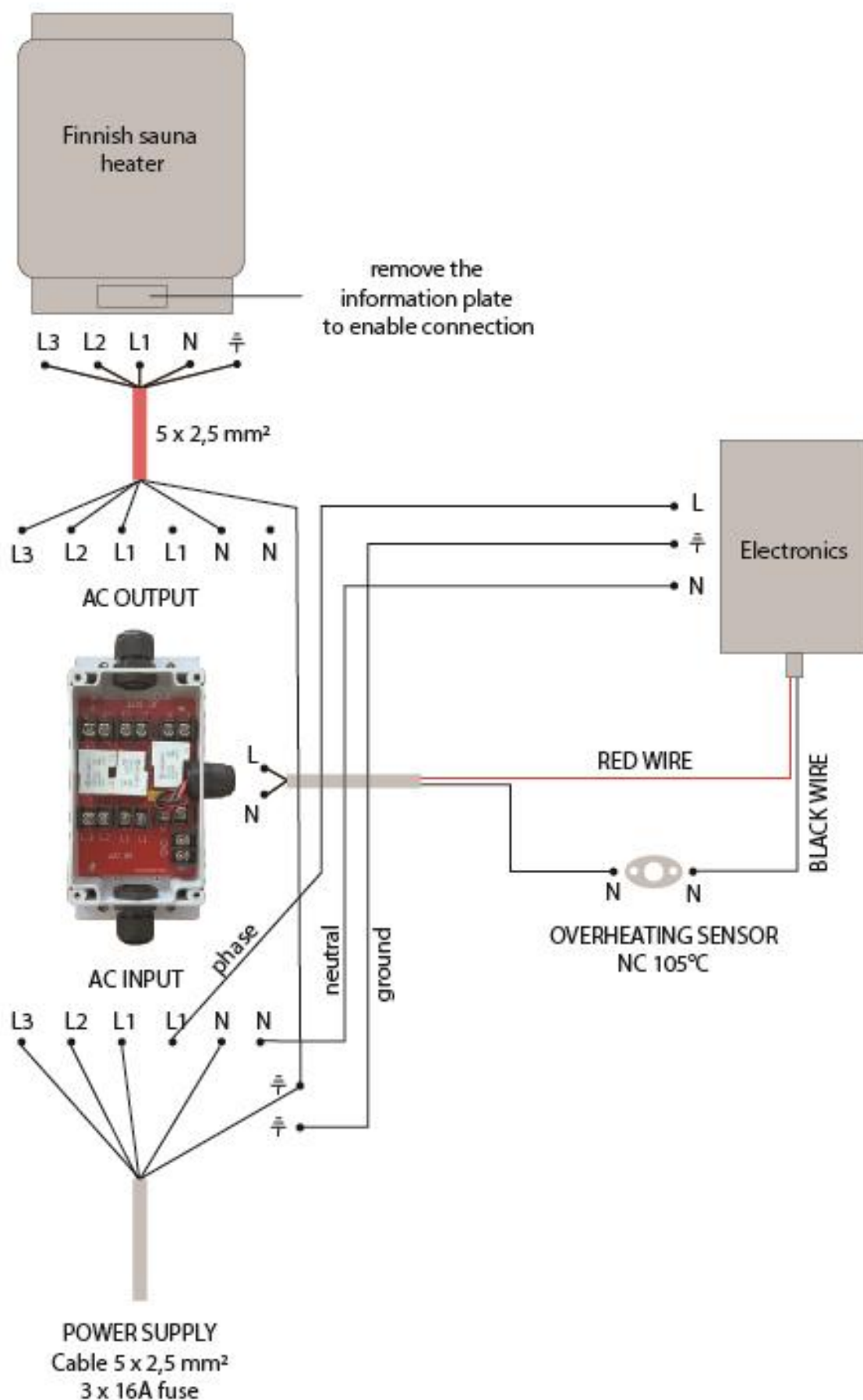

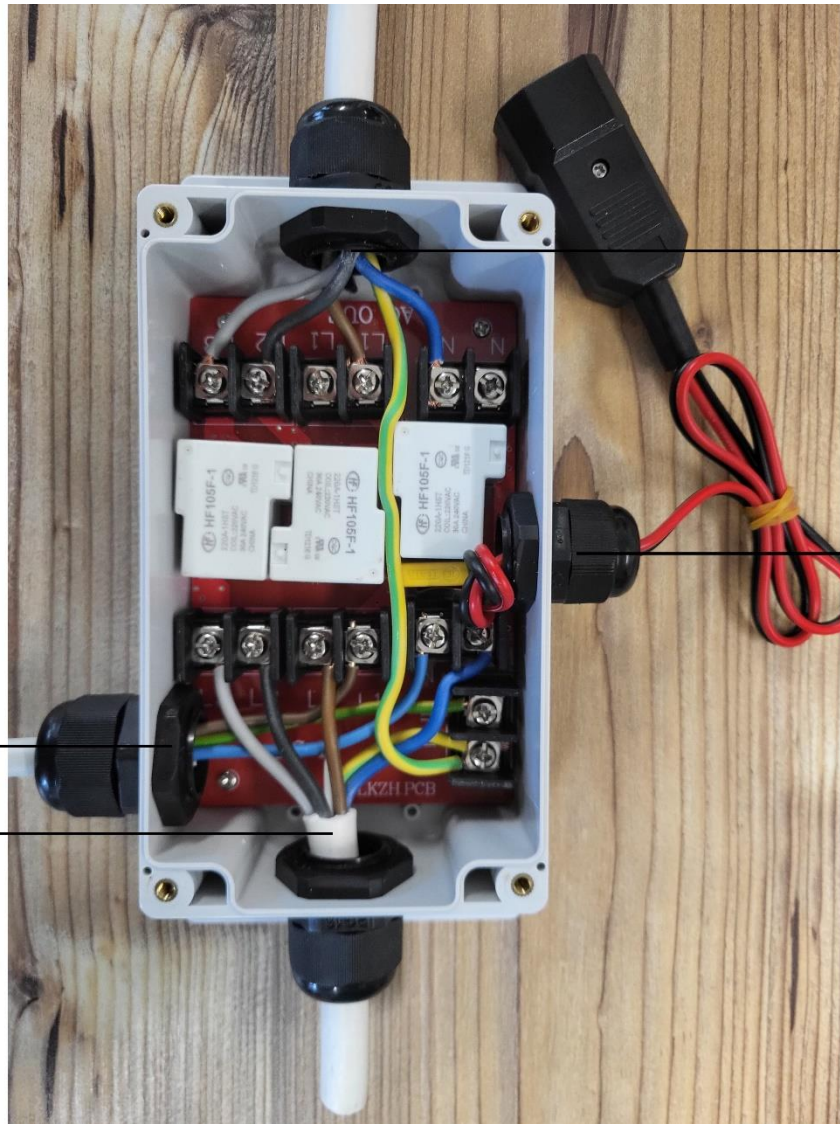

Control unit power supply

Your line (IN):
3 x 4 mm² conductor
or
5 x 2.5 mm² conductor
(0)

Line or guide
in the stove (OUT):
conductor 3 x 4 mm²
or
conductor 5 x 2.5 mm²
(0)

Communication with the
control unit

