



FINSKA SAVNA JF180

Specifikacije in navodila za sestavo

SLO

HR

EN



FINSKA SAVNA JF180

Specifikacije in navodila za sestavo

SLO

SPECIFIKACIJE

Model	JF180
Dimenzije	1800x1400x2005 mm
Število oseb	5
Les	Hemlock, 48 mm
Steklo	Prozorno, kaljeno, 8 mm
Tečaji	INOX
Upravljanje	Nadzorna plošča na tipke
Čas delovanja	Do 90 min
Temperatura	Do 90 °C
Prezračevanje	Da
Povezljivost	USB, Bluetooth, radio, aplikacija
Osvetlitev	LED RGB zvezdnato nebo
Peč	6 kW, s termostatom, časovnikom in vulkanskim kamenjem
Priklop	Trofazni: 400 V, 50 Hz ali vodnik 5 x 2,5 mm ² in 3 x 16 A varovalka
Teža	273 kg

SESTAVNI DELI

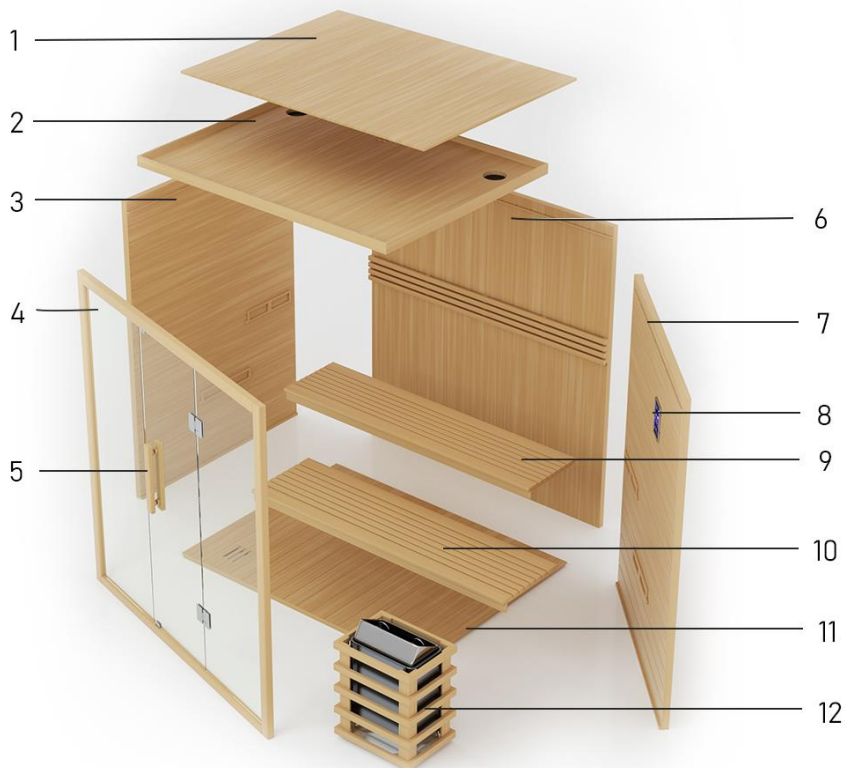

1 Pokrivna plošča*

2 Stropna plošča

3 Leva stranica

4 Prednja stranica

5 Ročaj

6 Hrbtna plošča

7 Desna stranica

8 Nadzorna plošča

9 zgornja klop

10 Spodnja klop

11 Dno

12 Grelec

*Novi modeli imajo pokrivno ploščo z izrezi.

SESTAVA SAVNE

Priporočeno orodje

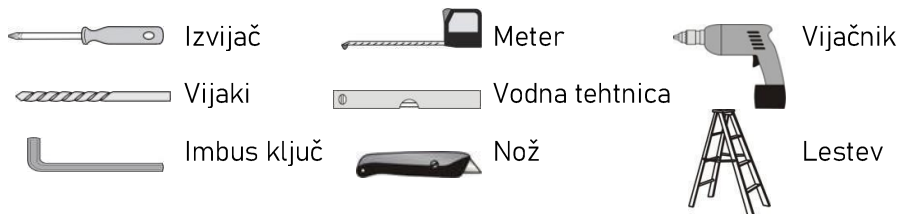

Nasveti za sestavo

Prosimo, odstranite transportno embalažo in preverite, ali je vaša savna dostavljena v celoti in nepoškodovana, preden začnete s sestavljanjem. Za sestavljanje savne sta potrebni vsaj tri osebe. Ročke za vrata se nahajajo pod pokrovom na stropu, katerega se odstrani – pod pokrovom nahaja vsa elektronika.

Koraki sestave



1. Hrbtne plošča



2. Leva stranica



3. Desna stranica



4. Dno



5. zgornja klop



6. Spodnja klop



7. Grelec



8. Prednja plošča



9. Ročaj



10. Stropna plošča



11. Pokrivna plošča

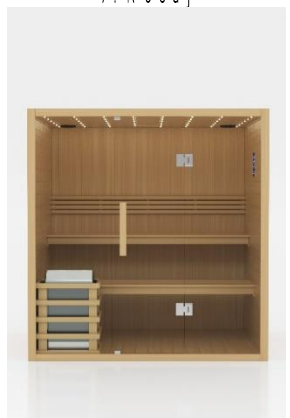

12. Sestavljena savna

Zunanja zaponka

Stranice savne sestavite skupaj z zaponko na zunanji strani.

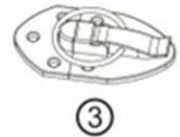
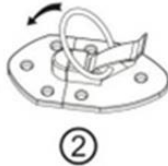
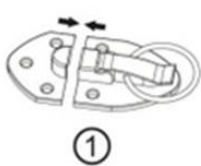

Priključitev električnih komponent



Priključite moder UTP kabel iz nadzorne plošče v nadzorno enoto savne.

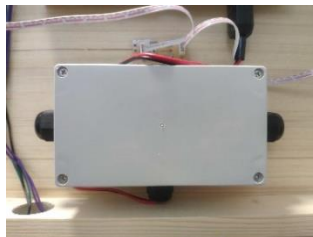

Na stropu se nahaja kontaktor.



Kontaktor odpremo, in ustrezno povežemo: AC in: napajanje od stranke AC out: kabel v stranici (glej shemo spodaj)

* v primeru nejasnosti pokličite na telefonsko številko 070 700 805.

Namestitev tečajev, ročaja in pokrova



1. Namestite tečaje – mehka dela morata biti ob steklu, na notranjosti tečajev



2. Namestite ročaj, vijaki iz notranje strani savne.



3. Namestite pokrivno ploščo

SHEMA VEZAVE

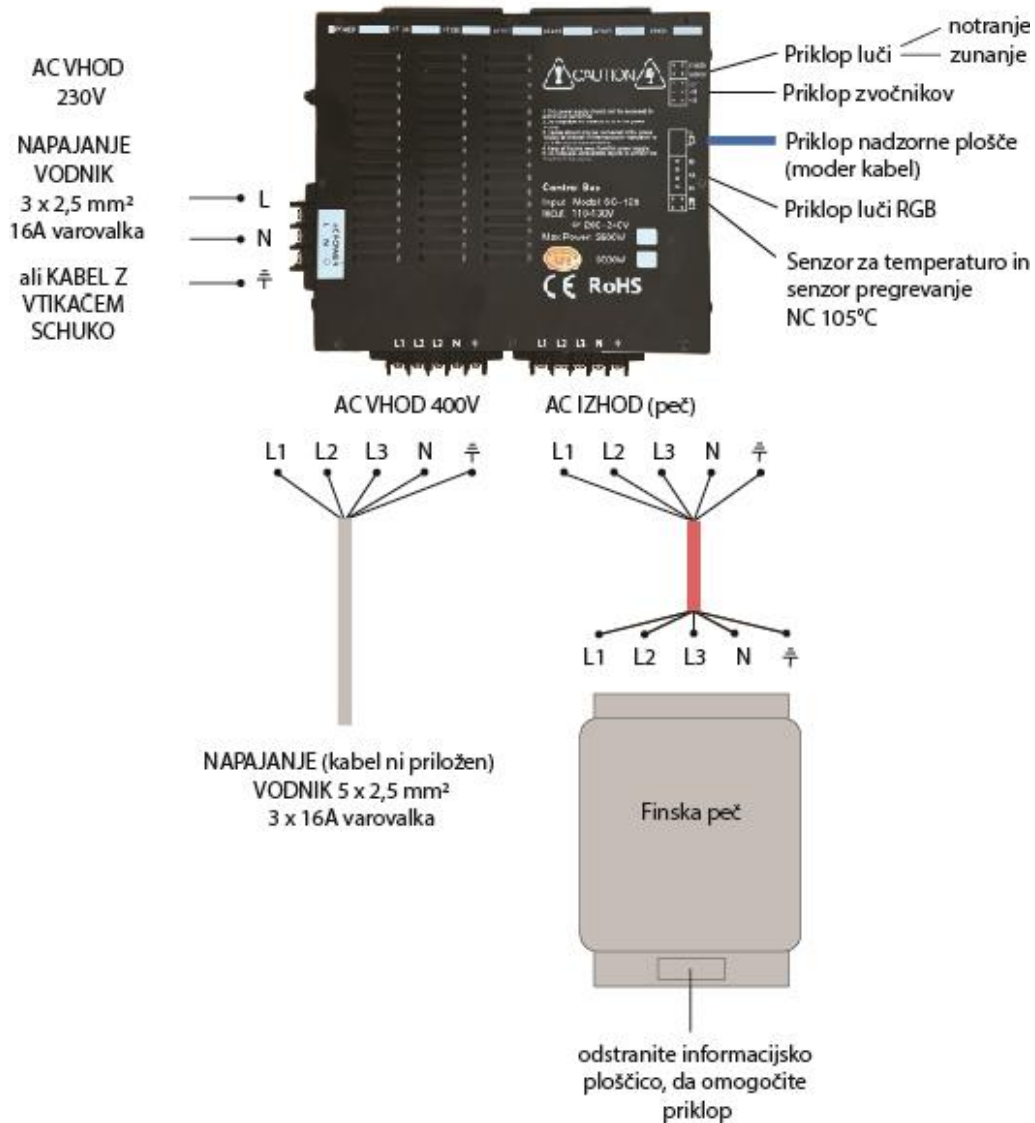

FINSKA SAUNA JF180

Specifikacije i upute za montažu

HR

SPECIFIKACIJE

Model	JF180
Dimenzije	1800x1400x2005 mm
Broj osoba	5
Drvo	Hemlock, 48 mm
Staklo	Prozirno, kaljeno, 8 mm
Šarke	INOX
Upravljanje	Upravljačka ploča s gumbima
Vrijeme rada	Do 90 min
Temperatura	Do 90 °C
Ventilacija	Da
Povezivost	USB, Bluetooth, radio, aplikacija
Rasvjeta	LED RGB zvjezdano nebo
Peć	6 kW, s termostatom, timerom i vulkanskim kamenom
Veza	Trofazni: 400 V, 50 Hz ili vodič 5 x 2,5 mm ² i 3 x 16 A osigurač
Težina	273 kg

SASTAVNI DJELOVI

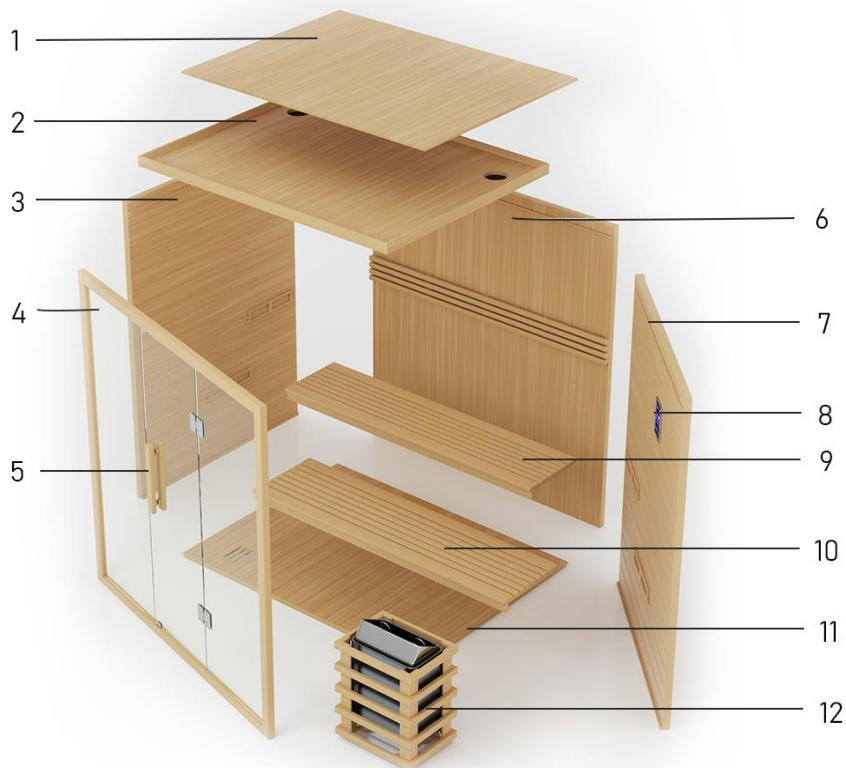

1 Pokrovna ploča*

2 Stropna ploča

3 Lijeva strana

4 Naslovnica

5 Ručke

6 Stražnja ploča

1 Pokrovna ploča

7 Desna strana

8 Upravljačka ploča

9 Gornja klupa

10 Donja klupa

11 Dno

12 Peć

7 Desna strana

*Novi modeli imaju pokrovnu ploču s izrezima.

SASTAVA SAUNE

Priporučeni alati

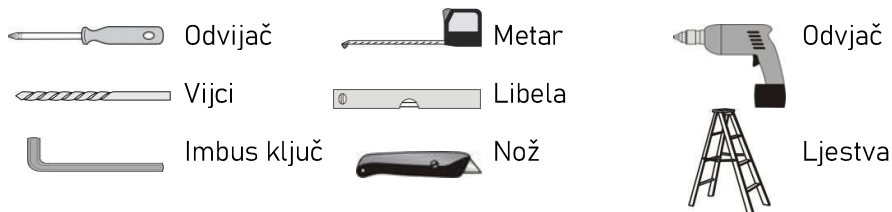

Savjeti za sastavljanje

Molimo Vas da uklonite ambalažu za otpremu i provjerite je li Vaša sauna isporučena potpuna i neoštećena prije početka sastavljanja. Za sastavljanje saune potrebne su najmanje tri osobe. Ručke na vratima nalaze se ispod uklonjivog stropnog pokrova - sva elektronika nalazi se ispod pokrova.

Koraci montaže





4. Dno



5. Gornja klupa



6. Donja klupa



7. Peć



8. Prednja ploča



9. Ručka



10. Stropna ploča



11. Pokrovnna ploča

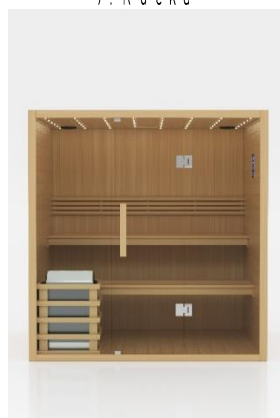

12. Montirana sauna

Vanjska kopča

Stranice saune sastavite zajedno pomoću kopče na vanjskoj strani.

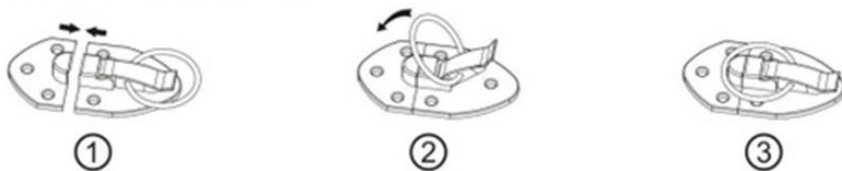

Spajanje električnih komponenti



1. Spojite plavi UTP kabel s upravljačke ploče na kontrolnu jedinicu saune.

2. Spojite kabele za napajanje između kontrolne ploče i peći.

* u slučaju nejasnoća nazovite +38670 700 805.

Ugradnja Šarki, ručke i poklopca



1. Instalirajte šarke - meki dijelovi moraju biti uz staklo, s unutarnje strane šarke



2. Postavite ručku, vijke s unutarnje strane saune.



3. Postavite pokrovnu ploču

SHEMA POVEZIVANJA

AC ULAZ
230V

NAPAJANJE
VODIC
3 x 2,5 mm²
16A osigurač

ili KABEL S
UTIKAČEM
SCHUKO

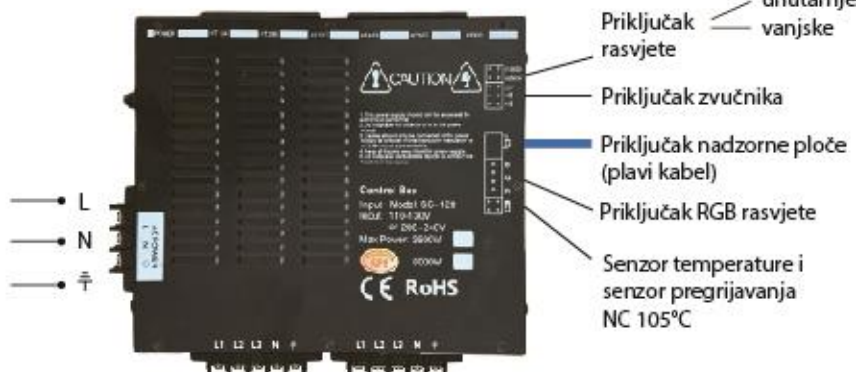

AC ULAZ 400V



AC IZLAZ (peć)

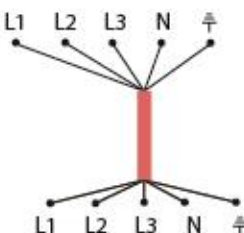

NAPAJANJE (kabel nije priložen)
VODIČ 5 x 2,5 mm²
3 x 16A osigurač



uklonite informacijsku pločicu
kako biste omogućili priključak

FINNISH SAUNA JF180

Specifications and assembly instructions

EN

SPECIFICATIONS

Model	JF180
Dimensions	1800x1400x2005 mm
Number of persons	5
Wood	Hemlock, 48 mm
Glass	Transparent, tempered, 8 mm
Hinges	INOX
Control	Control panel with buttons
Operating time	Up to 90 min
Temperature	Up to 90 °C
Ventilation	Yes
Connectivity	USB, Bluetooth, Radio, App
Lighting	LED RGB starry sky
Stove	6 kW, with thermostat, timer and volcanic stone
Connection	Three-phase: 400 V, 50 Hz or conductor 5 x 2,5 mm ² and 3 x 16 A fuse
Weight	273 kg

COMPONENTS

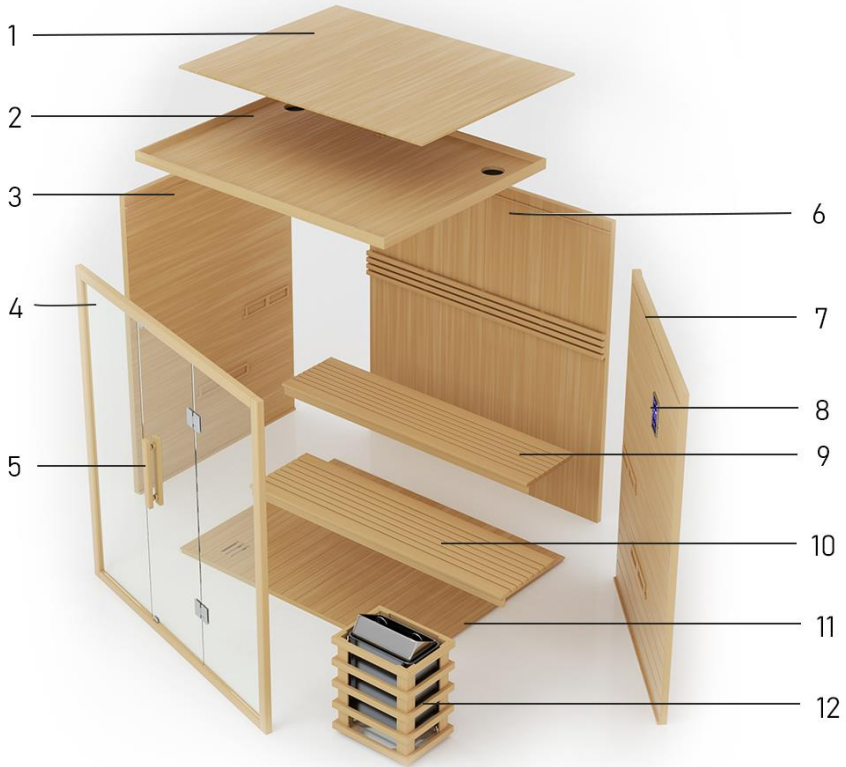

1 Cover plate*

2 Ceiling panel

3 Left side

4 Front page

5 Handle

6 Back plate

1 Cover plate

7 Right side

8 Control panel

9 Upper Bench

10 Lower Bench

11 Bottom

12 Sauna Heater

7 Right side

*New models have a cover panel with cut-outs.

SAUNA ASSEMBLY

Recommended tools

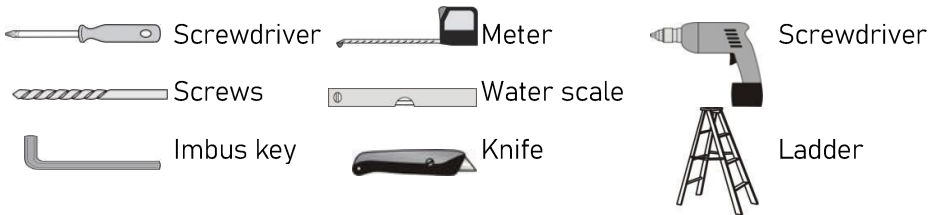

Assembly tips

Please remove the shipping packaging and verify that your sauna has been delivered complete and undamaged before beginning the assembly process. At least three people are required to assemble the sauna. The door handles are located under a removable ceiling cover - all electronics are located under the cover.

Assembly steps



1. Back plate



2. Left side



3. Right side



4. Bottom



5. Upper Bench



6. Lower Bench



7. Heater



8. Front Panel



9. Handle



10. Ceiling Panel



11. Cover Plate

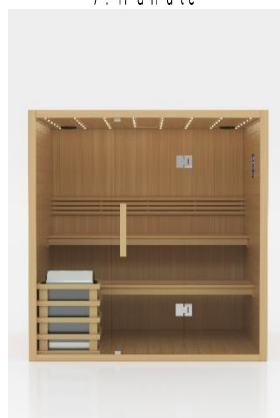

12. Finished Sauna

Outer buckle

Assemble the sauna sides together with the clamp on the outside.

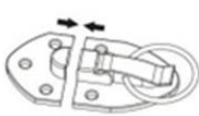

①



②



③

Connecting electrical components



1. Connect the blue UTP cable from the control panel to the sauna control unit.

2. Connect the power cables between the control unit and the stove.

* in case of ambiguity, call +38670 700 805.

Installation of hinges and handle



1. Install the hinges - the soft parts must be next to the glass, on the inside of the hinges



2. Install the handle, screws from the inside of the sauna.



3. Install the cover plate

WIRING DIAGRAM

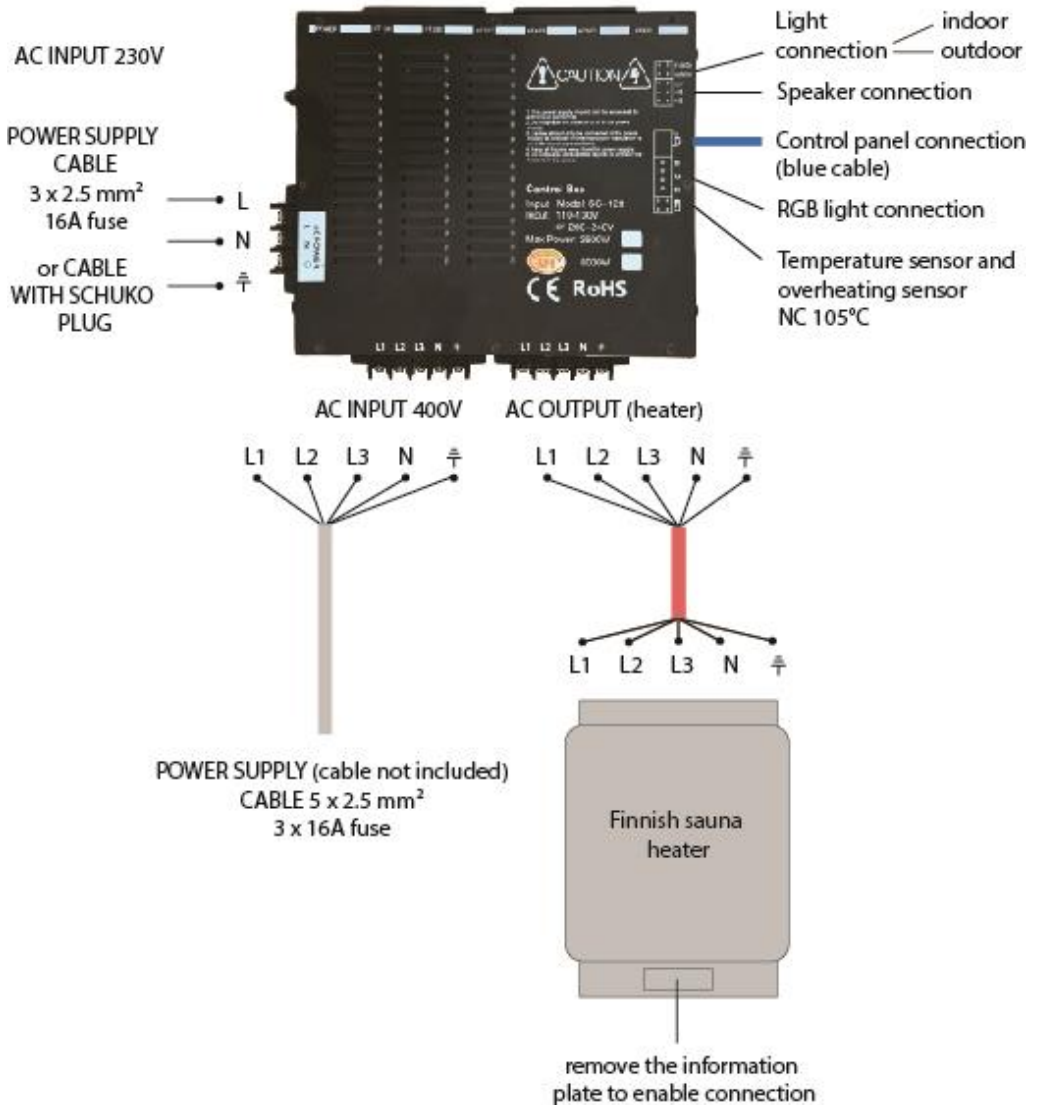

Zastopa in prodaja:

Jana Splet d.o.o.
Kolodvorska cesta 16a
1330 Kočevje
ID za DDV: SI26216477

Tel: +386 (0)70 700 805
Splet: www.jjspa.si
E-naslov: spa@jjana.si

