



# FINSKA SAVNA JF210

## Specifikacije in navodila za sestavo

SLO

HR

EN



# FINSKA SAVNA JF210

Specifikacije in navodila za sestavo

SLO

## SPECIFIKACIJE

Model	JF210
Dimenzije	2100x1600x2005 mm
Število oseb	6
Les	Hemlock, 48 mm
Steklo	Prozorno, kaljeno, 8 mm
Tečaji	INOX
Upravljanje	Nadzorna plošča na dotik
Čas delovanja	Do 90 min
Temperatura	Do 90 °C
Prezračevanje	Da
Povezljivost	USB, Bluetooth, radio, aplikacija
Osvetlitev	LED RGB zvezdnato nebo
Peč	9 kW, s termostatom, časovnikom in vulkanskim kamenjem
Priklop	Trofazni: 400 V, 50 Hz vodnik 5 x 2,5 mm <sup>2</sup> in 3 x 16 A varovalka
Teža	330 kg

## SESTAVNI DELI

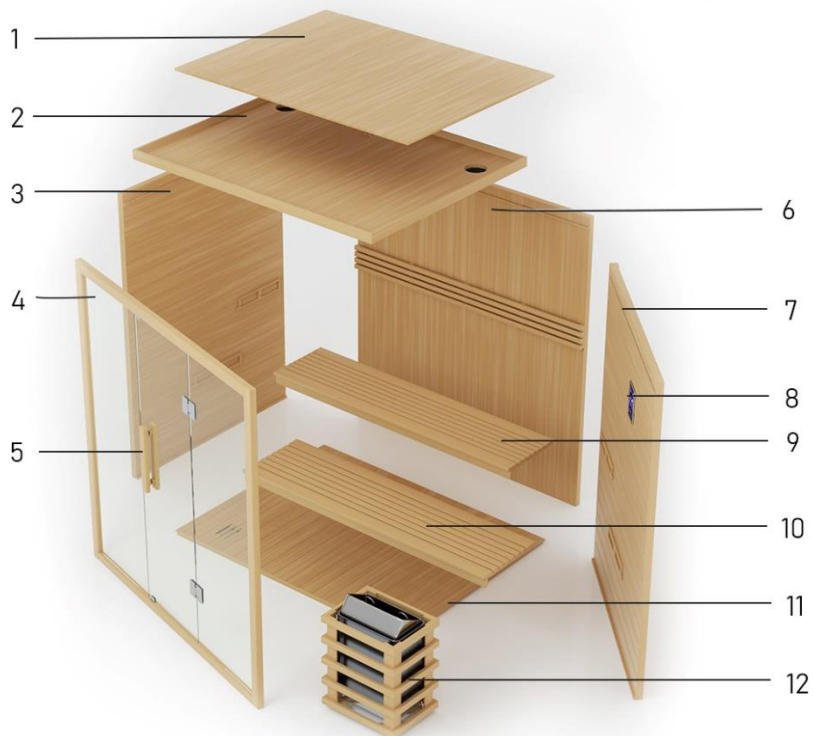

1 Pokrivna plošča\*

2 Stropna plošča

3 Leva stranica

4 Prednja stranica

5 Ročaj

6 Hrbtna plošča

7 Desna stranica

8 Nadzorna plošča

9 zgornja klop

10 Spodnja klop

11 Dno

12 Grelec

\*Novi modeli imajo pokrivno ploščo z izrezi.

## SESTAVA SAVNE

### Priporočeno orodje

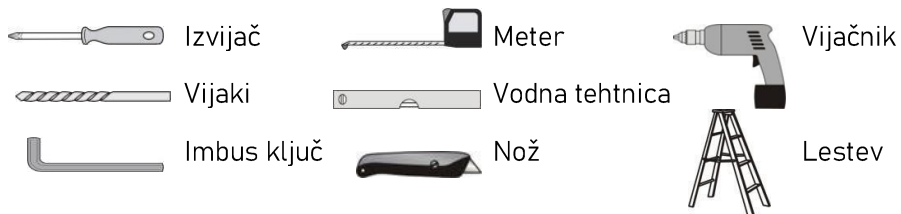

### Nasveti za sestavo

Prosimo, odstranite transportno embalažo in preverite, ali je vaša savna dostavljena v celoti in nepoškodovana, preden začnete s sestavljanjem. Za sestavljanje savne sta potrebni vsaj tri osebe. Ročke za vrata se nahajajo pod pokrovom na stropu, katerega se odstrani – pod pokrovom nahaja vsa elektronika.

### Koraki sestave



1. Hrbtna plošča



2. Leva stranica



3. Desna stranica



4. Dno



5. zgornja klop



6. Spodnja klop



7. Grelec



8. Prednja plošča



9. Ročaj



10. Stropna plošča



11. Pokrivna plošča

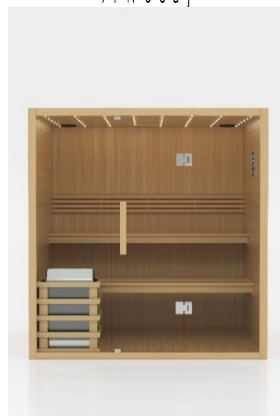

12. Sestavljena savna



## Namestitev tečajev, ročaja in pokrova



1. Namestite tečaje – mehka dela morata biti ob steklu, na notranjosti tečajev



2. Namestite ročaj, vijaki iz notranje strani savne.



3. Namestite pokrivno ploščo

# SHEMA VEZAVE

AC VHOD  
230V

NAPAJANJE  
VODNIK  
3 x 2,5 mm<sup>2</sup>  
16A varovalka

ali KABEL Z  
VTIKAČEM  
SCHUKO



Priklop luči — notranje  
Priklop luči — zunanje

Priklop zvočnikov

Priklop nadzorne plošče  
(moder kabel)

Priklop luči RGB

Senzor za temperaturo in  
senzor pregrevanje  
NC 105°C

AC VHOD 400V

L1 L2 L3 N ⚡

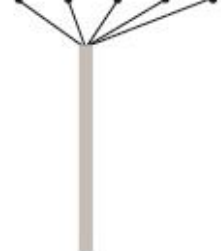

NAPAJANJE (kabel ni priložen)  
VODNIK 5 x 2,5 mm<sup>2</sup>  
3 x 16A varovalka

AC IZHOD (peč)

L1 L2 L3 N ⚡

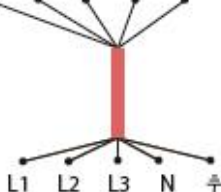

odstranite informacijsko  
ploščico, da omogočite  
priklop

# FINSKA SAUNA JF210

Specifikacije i upute za montažu

HR

## SPECIFIKACIJE

Model	JF210
Dimenzije	2100x1600x2005 mm
Broj osoba	6
Drvo	Hemlock, 48 mm
Staklo	Prozirno, kaljeno, 8 mm
Šarke	INOX
Upravljanje	Upravljačka ploča na dodir
Vrijeme rada	Do 90 min
Temperatura	Do 90 °C
Ventilacija	Da
Povezivost	USB, Bluetooth, radio, aplikacija
Rasvjeta	LED RGB zvjezdano nebo
Peć	9 kW, s termostatom, timerom i vulkanskim kamenom
Veza	Trofazni: 400 V, 50 Hz vodič 5 x 2,5 mm <sup>2</sup> in 3 x 16 A osigurač
Težina	330 kg

## SASTAVNI DJELOVI

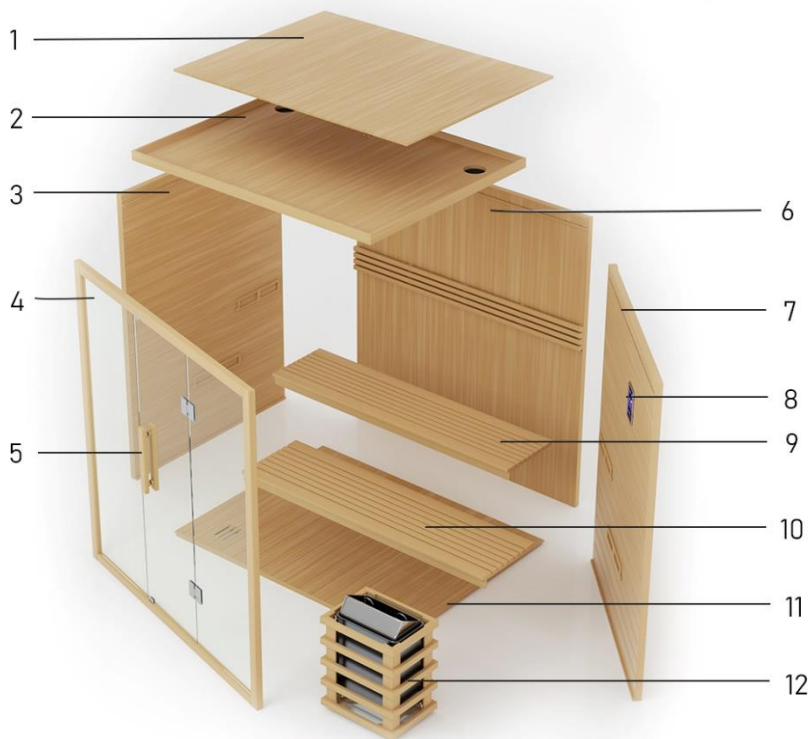

1 Pokrovna ploča\*

2 Stropna ploča

3 Lijeva strana

4 Naslovnica

5 Ručke

6 Stražnja ploča

7 Desna strana

8 Upravljačka ploča

9 Gornja klupa

10 Donja klupa

11 Dno

12 Peć

\*Novi modeli imaju pokrovnu ploču s izrezima.

# SASTAVA SAUNE

## Priporučeni alati

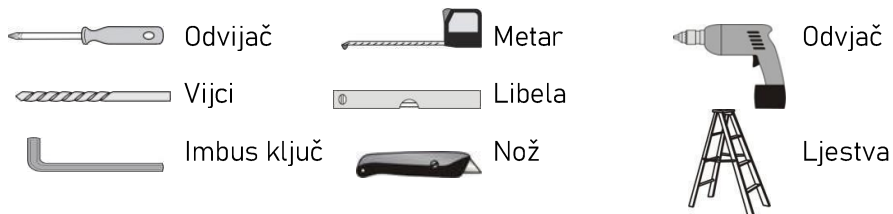

## Savjeti za sastavljanje

Molimo Vas da uklonite ambalažu za otpremu i provjerite je li Vaša sauna isporučena potpuna i neoštećena prije početka sastavljanja. Za sastavljanje saune potrebne su najmanje tri osobe. Ručke na vratima nalaze se ispod uklonjivog stropnog pokrova - sva elektronika nalazi se ispod pokrova.

## Koraci montaže



1. Stražnja ploča



2. Lijeva strana



3. Desna strana



4. Dno



5. Gornja klupa



6. Donja klupa



7. Peć



8. Prednja ploča



9. Ručka



10. Stropna ploča



11. Pokrovnna ploča

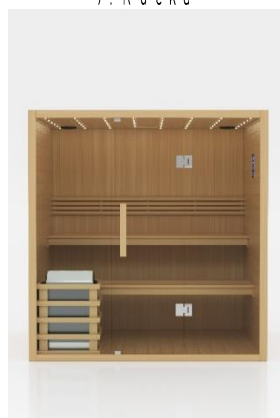

12. Montirana sauna

## Vanjska kopča

Stranice saune sastavite zajedno pomoću kopče na vanjskoj strani.

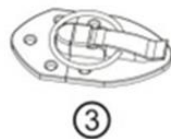
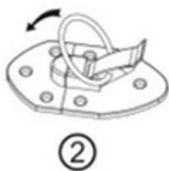
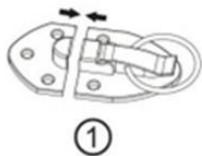

## Spajanje električnih komponenti



1. Spojite plavi UTP kabel s upravljačke ploče na kontrolnu jedinicu saune.

2. Spojite kabele za napajanje između kontrolne ploče i peći.

\* u slučaju nejasnoća nazovite +38670 700 805.

## Ugradnja Šarki, ručke i poklopca



1. Instalirajte šarke - meki dijelovi moraju biti uz staklo, s unutarnje strane šarke



2. Postavite ručku, vijke s unutarnje strane saune.



3. Postavite pokrovnu ploču

# SHEMA POVEZIVANJA

AC ULAZ  
230V

NAPAJANJE  
VODIČ  
3 x 2,5 mm<sup>2</sup>  
16A osigurač

ili KABEL S  
UTIKAČEM  
SCHUKO

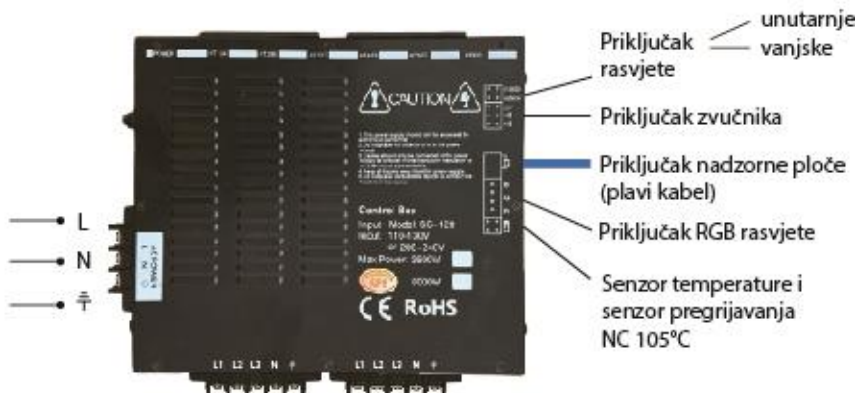

AC ULAZ 400V



NAPAJANJE (kabel nije priložen)  
VODIČ 5 x 2,5 mm<sup>2</sup>  
3 x 16A osigurač

AC IZLAZ (peć)

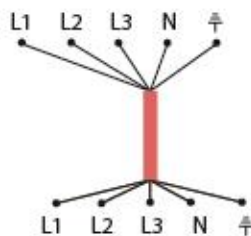

uklonite informacijsku pločicu  
kako biste omogućili priključak

# FINNISH SAUNA JF210

Specifications and assembly instructions

EN

## SPECIFICATIONS

Model	JF210
Dimensions	2100x1600x2005 mm
Number of persons	6
Wood	Hemlock, 48 mm
Glass	Transparent, tempered, 8 mm
Hinges	INOX
Control	Touch control panel
Operating time	Up to 90 min
Temperature	Up to 90 °C
Ventilation	Yes
Connectivity	USB, Bluetooth, Radio, App
Lighting	LED RGB starry sky
Stove	9 kW, with thermostat, timer and volcanic stone
Connection	Three-phase: 400 V, 50 Hz, conductor 5 x 2,5 mm <sup>2</sup> and 3 x 16 A fuse
Weight	330 kg

# COMPONENTS

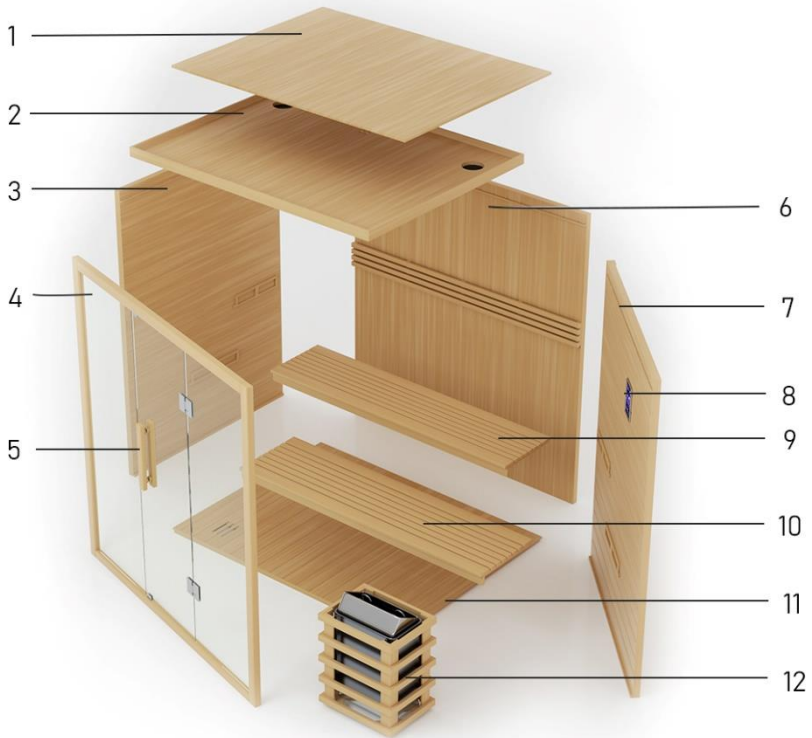

1 Cover plate\*

2 Ceiling panel

3 Left side

4 Front page

5 Handle

6 Back plate

7 Right side

8 Control panel

9 Upper Bench

10 Lower Bench

11 Bottom

12 Stove

\*New models have a cover panel with cut-outs.

# SAUNA ASSEMBLY

## Recommended tools

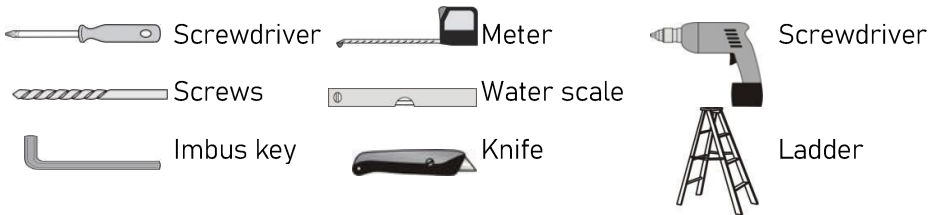

## Assembly tips

Please remove the shipping packaging and verify that your sauna has been delivered complete and undamaged before beginning the assembly process. At least three people are required to assemble the sauna. The door handles are located under a removable ceiling cover - all electronics are located under the cover.

## Assembly steps



1. Back plate



2. Left side



3. Right side



4. Bottom



5. upper bench



6. Lower bench



7. Heater



8. Front panel



9. Handle



10. Ceiling panel



11. Cover plate

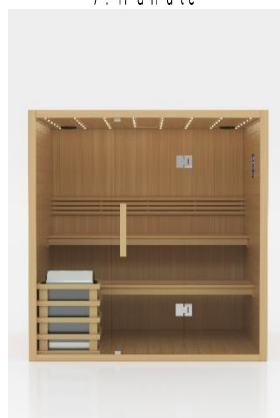

12. Composite sauna

## Outer buckle

Assemble the sauna sides together with the clasp on the outside.

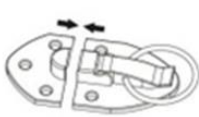

①



②



③

## Connecting electrical components



1. Connect the blue UTP cable from the control panel to the sauna control unit.

2. Connect the power cables between the control unit and the stove.

\* in case of ambiguity, call +38670 700 805.

## Installation of hinges and handle



1. Install the hinges - the soft parts must be next to the glass, on the inside of the hinges



2. Install the handle, screws from the inside of the sauna.



3. Install the cover plate

# WIRING DIAGRAM

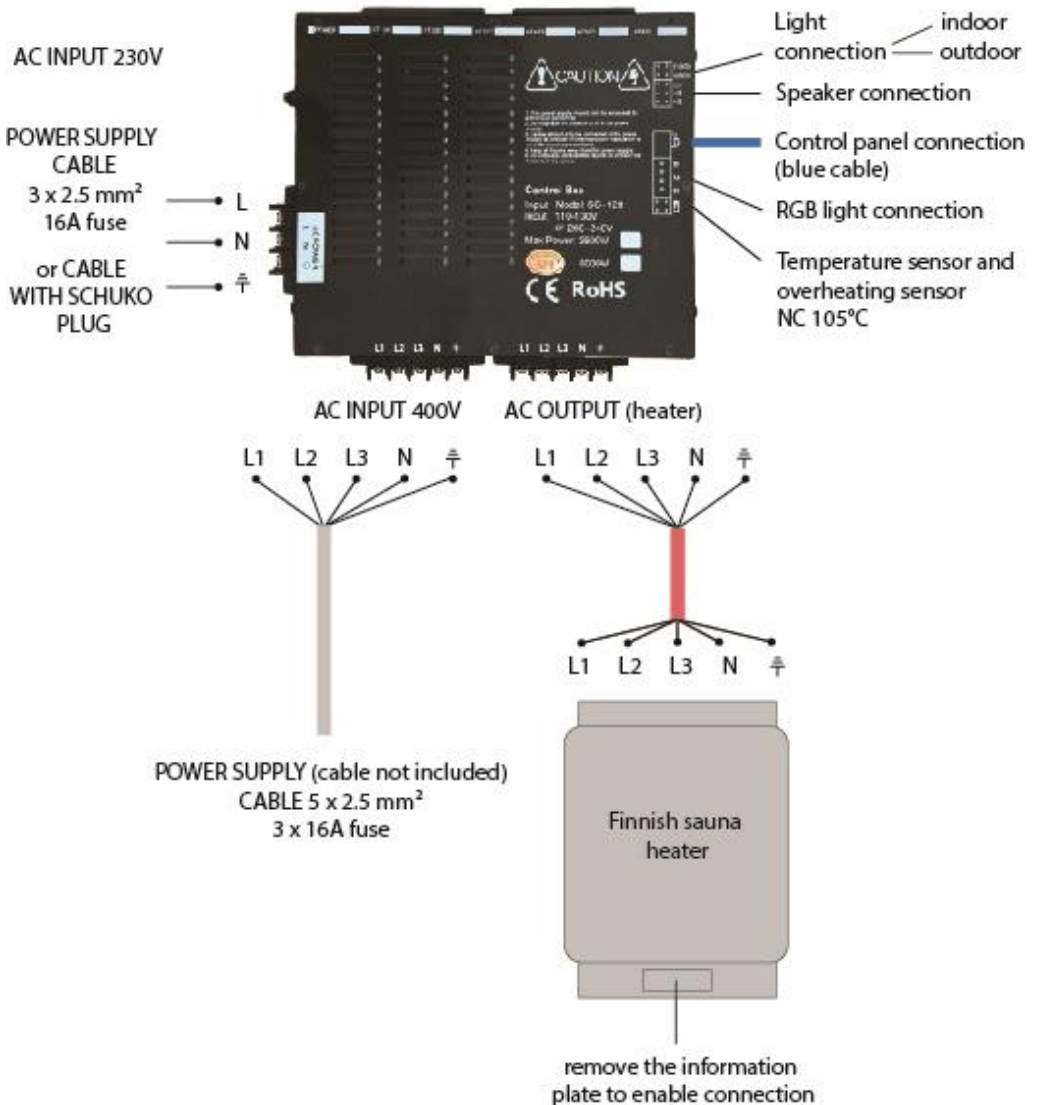

## Zastopa in prodaja:

Jana Splet d.o.o.  
Kolodvorska cesta 16a  
1330 Kočevje  
ID za DDV: SI26216477

Tel: +386 (0)70 700 805  
Splet: [www.jjspa.si](http://www.jjspa.si)  
E-naslov: [spa@jjana.si](mailto:spa@jjana.si)

