



FINSKA SAVNA JFP220

Specifikacije in navodila za sestavo

SLO

HR

EN

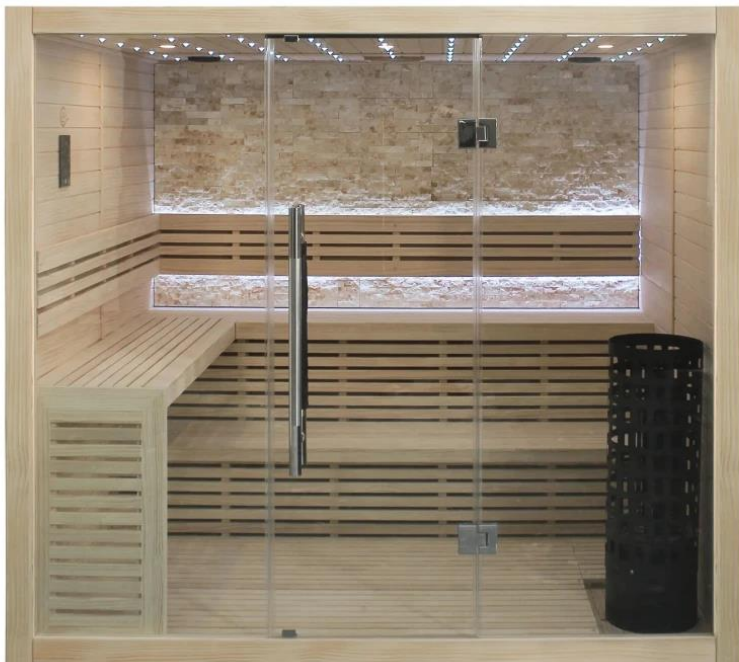

FINSKA SAVNA JFP220

Specifikacije in navodila za sestavo

SLO

SPECIFIKACIJE

Model	JFP220
Dimenzije	2200x1800x2000 mm
Število oseb	6
Les	Finski bor, 48 mm
Steklo	Prozorno, kaljeno, 8 mm
Tečaji	INOX
Upravljanje	Nadzorna plošča na dotik
Čas delovanja	Do 90 min
Temperatura	Do 90 °C
Prezračevanje	Da
Povezljivost	Bluetooth, radio, aplikacija
Osvetlitev	LED RGB zvezdnato nebo in trak
Peč	9 kW, s termostatom, časovnikom in vulkanskim kamenjem
Priklop	Trofazni vir: 400 V, 50 Hz, vodnik 5 x 2,5 mm ² in 3 x 16 A varovalka
Teža	295 kg

SESTAVNI DELI

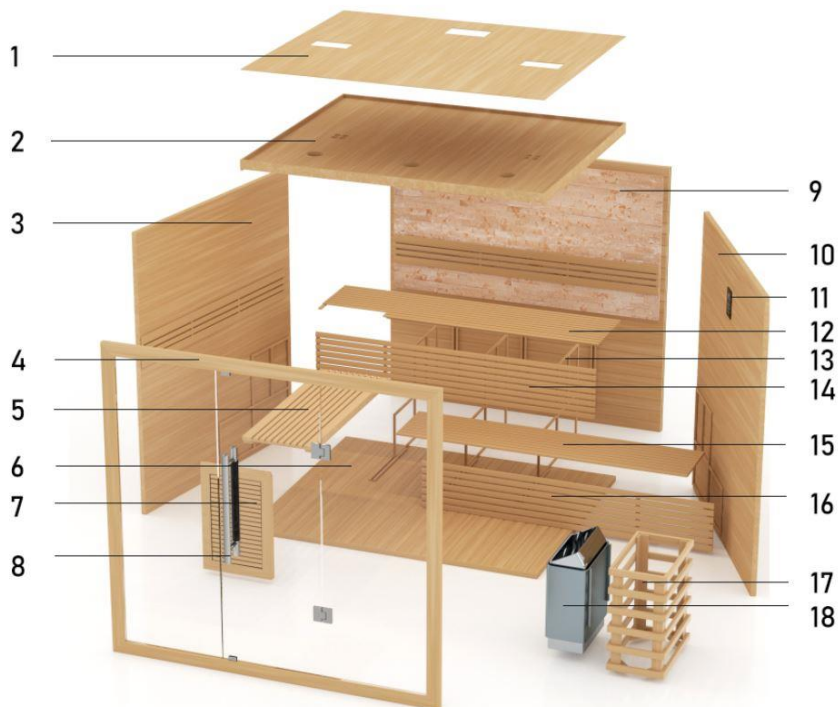

1 Pokrivna plošča*

2 Stropna plošča

3 Leva stranica

4 Prednja plošča s steklom

5 Leva zgornja klop

6 Dno

7 Stranica klopi

8 Prednja stranica spodnje klopi

9 Hrbtna plošča

10 Desna stranica

11 Nadzorna plošča

12 Zgornja klop

13 Nosilci klopi

14 Prednja stranica zgornje klopi

15 Spodnja klop

16 prednja stranica spodnje klopi

17 Okvir peči

18 Peč

*Novi modeli imajo pokrivno ploščo z izrezi.

SESTAVA SAVNE

Priporočeno orodje

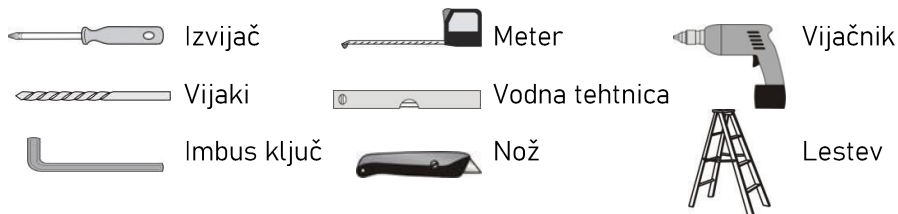

Nasveti za sestavo

Prosimo, odstranite transportno embalažo in preverite, ali je vaša savna dostavljena v celoti in nepoškodovana, preden začnete s sestavljanjem. Za sestavljanje savne sta potrebni vsaj dve osebi.

Koraki sestave



1. Hrbtne plošče



2. Leva stranica –
zaprinite zaponke



3. Desna stranica –
zaprinite zaponke



4. Dno



5. Nosilci klopi



6. Prednja stranica
spodnje klopi



7. Spodnja klop



8. Prednja stranica
zgornje klopi



9. Zgornja klop



10. Stranica klopi



11. Leva zgornja klop



12. Prednja plošča s
steklom
*Glej navodila spodaj.



13. INOX ročaj –
oblazinjen del na
notranjost savne



14. Stropna plošča

*po montaži stropa
priključite električne
komponente kot je
opisano v odstavku
»Priključitev električnih
komponent«



15. Pokrivna
plošča



16. Okvir peči in
peč

Zunanja zaponka

Stranice savne sestavite skupaj z zaponko na zunanji strani.

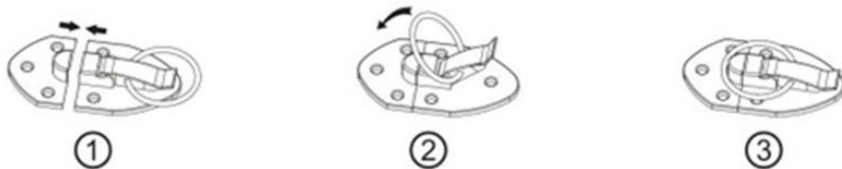

Priključitev električnih komponent



1. Priključite moder UTP kabel iz nadzorne plošče v nadzorno enoto savne.



2. Povežite kable zvezdnatega neba in spojite druge kable (nadzorna plošča in zvočniki)

* v primeru nejasnosti pokličite na telefonsko številko 070 700 805.

Namestitev tečajev, ročaja in pokrova



1. Namestite tečaje – mehka dela morata biti ob steklu, na notranjosti tečajev



2. Namestite ročaj, vijaki iz notranje strani savne.



3. Namestite pokrивно ploščo

SHEMA VEZAVE

AC VHOD
230V

NAPAJANJE
VODNIK
3 x 2,5 mm²
16A varovalka

ali KABEL Z
VTIKAČEM
SCHUKO



Priklop luči — notranje
Priklop luči — zunanje

Priklop zvočnikov

Priklop nadzorne plošče
(moder kabel)

Priklop luči RGB

Senzor za temperaturo in
senzor pregrevanje
NC 105°C

AC VHOD 400V

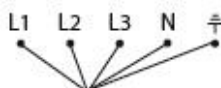

NAPAJANJE (kabel ni priložen)
VODNIK 5 x 2,5 mm²
3 x 16A varovalka

AC IZHOD (peč)

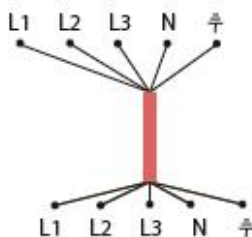

odstranite informacijsko
ploščico, da omogočite
priklop

FINSKA SAVNA JFP220

Specifikacije i upute za montažu

HR

SPECIFIKACIJE

Model	JFP220
Dimenzije	2200x1800x2000 mm
Broj osoba	6
Drvo	Finski bor, 48 mm
Staklo	Prozirno, kaljeno, 8 mm
Šarke	INOX
Upravljanje	Kontrolna ploča na dodir
Vrijeme rada	Do 90 min
Temperatura	Do 90 °C
Ventilacija	Da
Povezivost	Bluetooth, radio, aplikacija
Rasvjeta	LED RGB zvjezdano nebo
Peć	9 kW, s termostatom, timerom i vulkanskim kamenom
Veza	Trifazna struja: 400V, vodič 5 x 2,5 mm ² i 3 x 16 A osigurač
Težina	295 kg

SASTAVNI DJELOVI

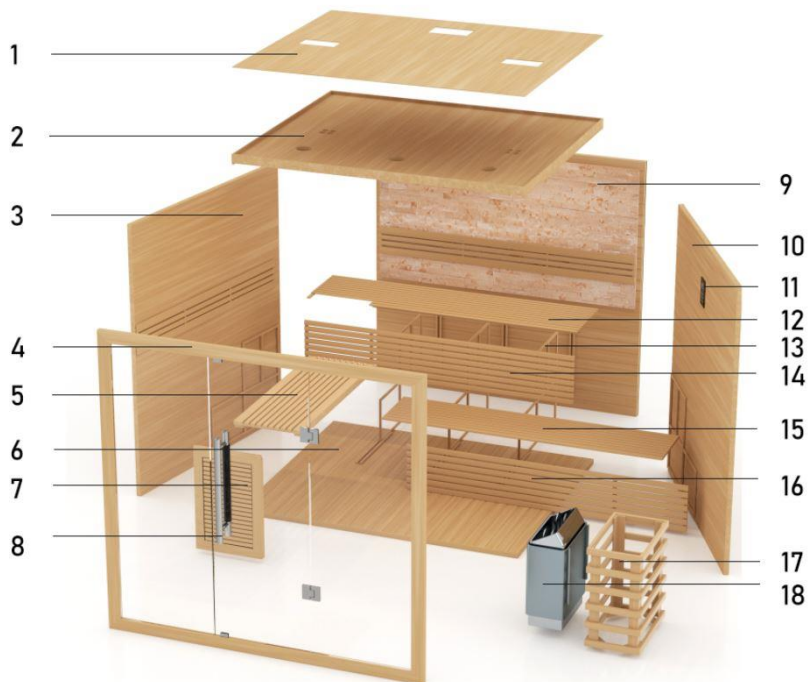

- | | |
|------------------------------|--------------------------------|
| 1 Pokrovna ploča* | 10 Desna strana |
| 2 Stropna ploča | 11 Upravljačka ploča |
| 3 Lijeva strana | 12 Gornja klupa |
| 4 Prednja ploča sa staklom | 13 Nosači klupa |
| 5 Lijeva gornja klupa | 14 Prednja strana gornje klupe |
| 6 Dno | 15 Donja klupa |
| 7 Strana klupe | 16 Prednja strana donje klupe |
| 8 Prednja strana donje klupe | 17 Okvir peći |
| 9 Hrbtina ploča | 18 Peć |

*Novi modeli imaju pokrovnu ploču s izrezima.

SASTAVA SAUNE

Priporučeni alati

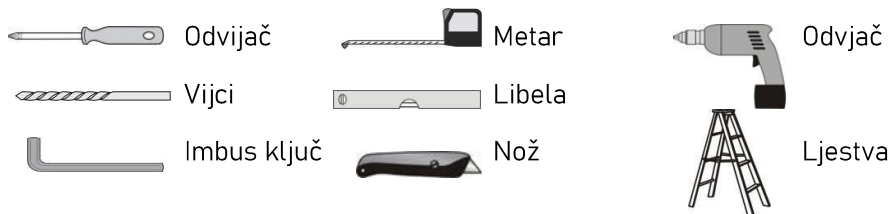

Savjeti za sastavljanje

Prije početka montaže uklonite transportnu ambalažu i provjerite je li vaša sauna isporučena kompletna i neoštećena. Za sastavljanje saune potrebne su najmanje dvije osobe.

Koraci montaže



1. Stražnja ploča



2. Desna strana –
zakopčajte kopče



3. Lijeva strana –
zakopčajte kopče



4. Dno



5. Držači za klupe



6. Prednja strana donje klupe



7. Donja klupa



8. Prednja strana gornje klupe



9. Gornja klupa



10. Stranica klupe



11. Lijevo gornja klupa



12. Prednja ploča sa staklom
*Pogledajte upute u nastavku.



13. INOX ručka



14. Peć i okvir peći

*nakon postavljanja stropa spojite električne komponente kako je opisano u odlomku "Spajanje električnih komponenti"



15. Poklopac, pokrovna ploča



16. Peć i okvir peći.

Vanjska kopča

Stranice saune sastavite zajedno pomoću kopče na vanjskoj strani.

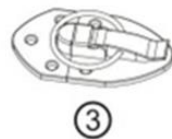
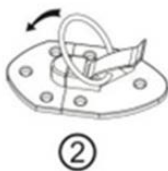
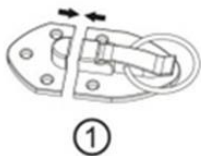

Spajanje električnih komponenti



1. Spojite plavi UTP kabel s upravljačke ploče na kontrolnu jedinicu saune.



2. Spojite kabele zvjezdanog neba i spojite ostale kabele (upravljačka ploča i zvučnici)

* u slučaju nejasnoća nazovite +38670 700 805.

Ugradnja Šarki, ručke i poklopca



1. Instalirajte šarke - meki dijelovi moraju biti uz staklo, s unutarnje strane šarke



2. Postavite ručku, vijke s unutarnje strane saune.



3. Postavite pokrovnu ploču

SHEMA POVEZIVANJA

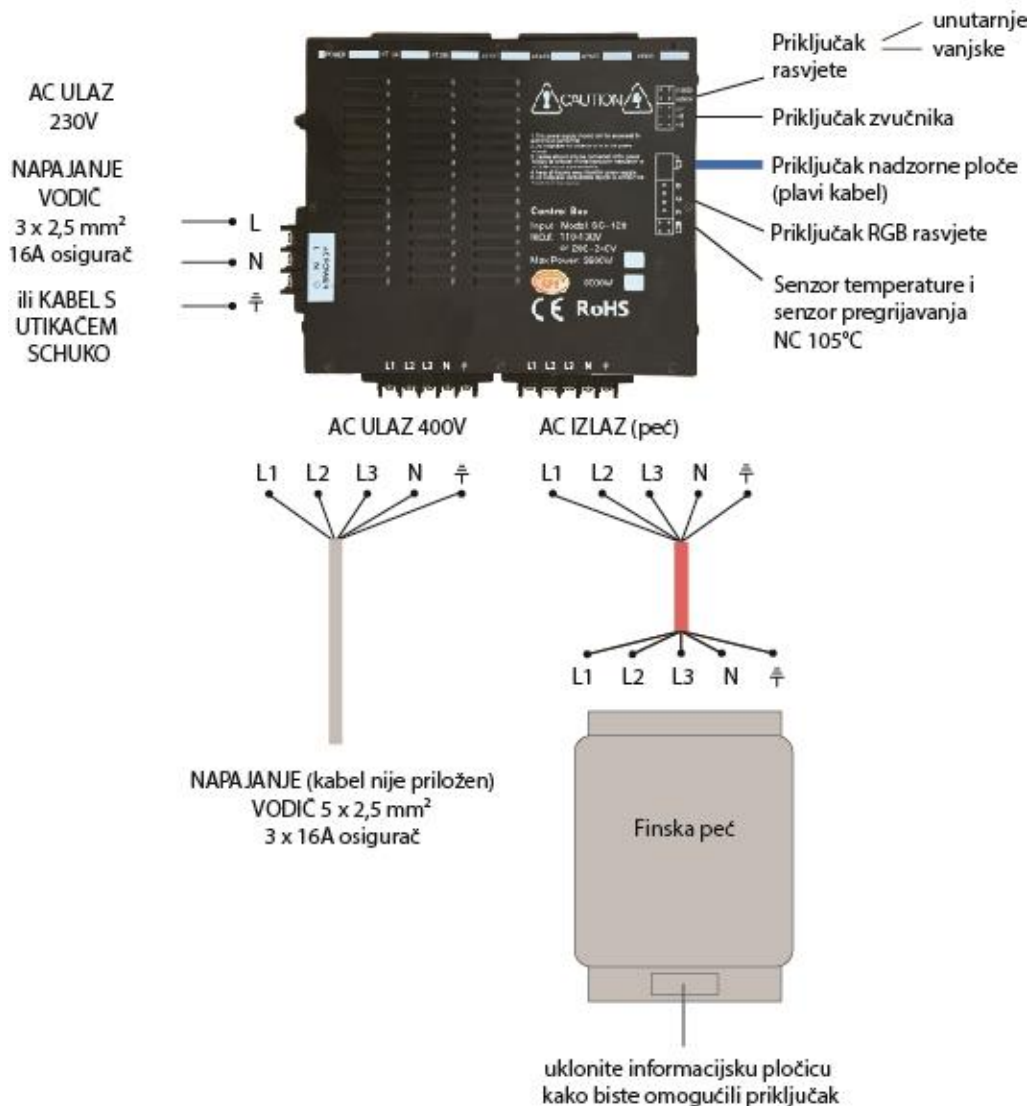

FINNISH SAUNA JFP220

Specifications and assembly instructions

EN

SPECIFICATIONS

Model	JFP220
Dimensions	2200x1800x2000 mm
Number of persons	6
Wood	Finnish pine, 48 mm
Glass	Transparent, tempered, 8 mm
Hinges	Stainless Steel
Control	Touch control panel
Operating time	Up to 90 min
Temperature	Up to 90 °C
Ventilation	Yes
Connectivity	Bluetooth, Radio, App
Lighting	LED RGB starry sky
Heater	9 kW, with thermostat, timer and volcanic stone
Connection	Three phase: 400 V, conductor 5 x 2,5 mm ² and 3 x 16 A fuse
Weight	295 kg

COMPONENTS

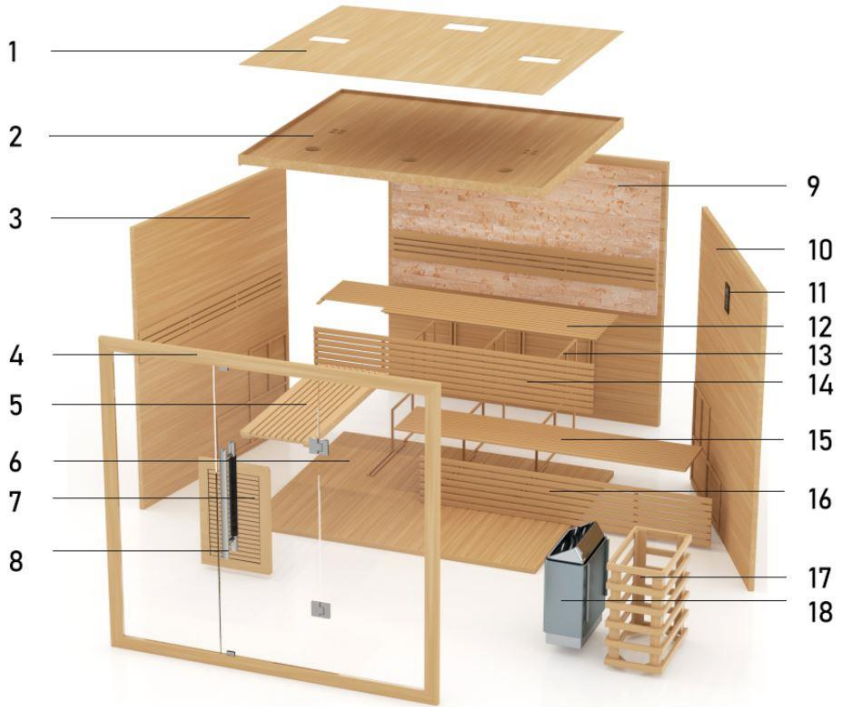

2 Ceiling panel

3 Left side

4 Front panel with glass

5 Left upper bench

6 Bottom plate

7 Bench side

8 Front side of the lower bench

9 Backplate

11 Control panel

12 Upper bench

13 Bench holders

14 Front side of the upper bench

15 Lower bench

16 Front side of the lower bench

17 Stove frame

18 Stove

*New models have a cover panel with cut-outs

SAUNA ASSEMBLY

Recommended tools

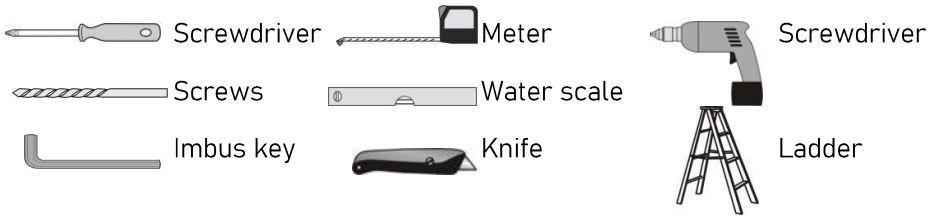

Assembly tips

Please remove the transport packaging and check that your sauna has been delivered complete and undamaged before starting assembly. At least two people are needed to assemble the sauna.

Assembly steps



1. Back plate



2. Right side



3. Left side



4. Bottom



5. Bench holders



6. The front side of the lower bench



7. Bench



8. The front side of the upper bench



9. Upper bench



10. Bench side



11. Left upper bench



12. Front panel with glass
*check instructions below



13. Handle



14. Ceiling plate

*after installing the ceiling, connect the electrical components as described in the paragraph "Connecting the electrical components"



15. Cover plate



16. 16 Stove frame and stove

Outer buckle

Assemble the sauna sides together with the clasp on the outside.

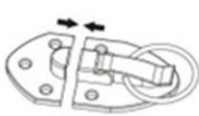

①



②

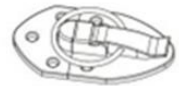

③

Connecting electrical components



1. Connect the blue UTP cable from the control panel to the sauna control unit.

2. Connect the starry sky cables and connect the other cables (control panel and speakers)

* in case of ambiguity, call +38670 700 805.

Installation of hinges and handle



1. Install the hinges - the soft parts must be next to the glass, on the inside of the hinges



2. Install the handle, screws from the inside of the sauna.



3. Install the cover plate

WIRING DIAGRAM

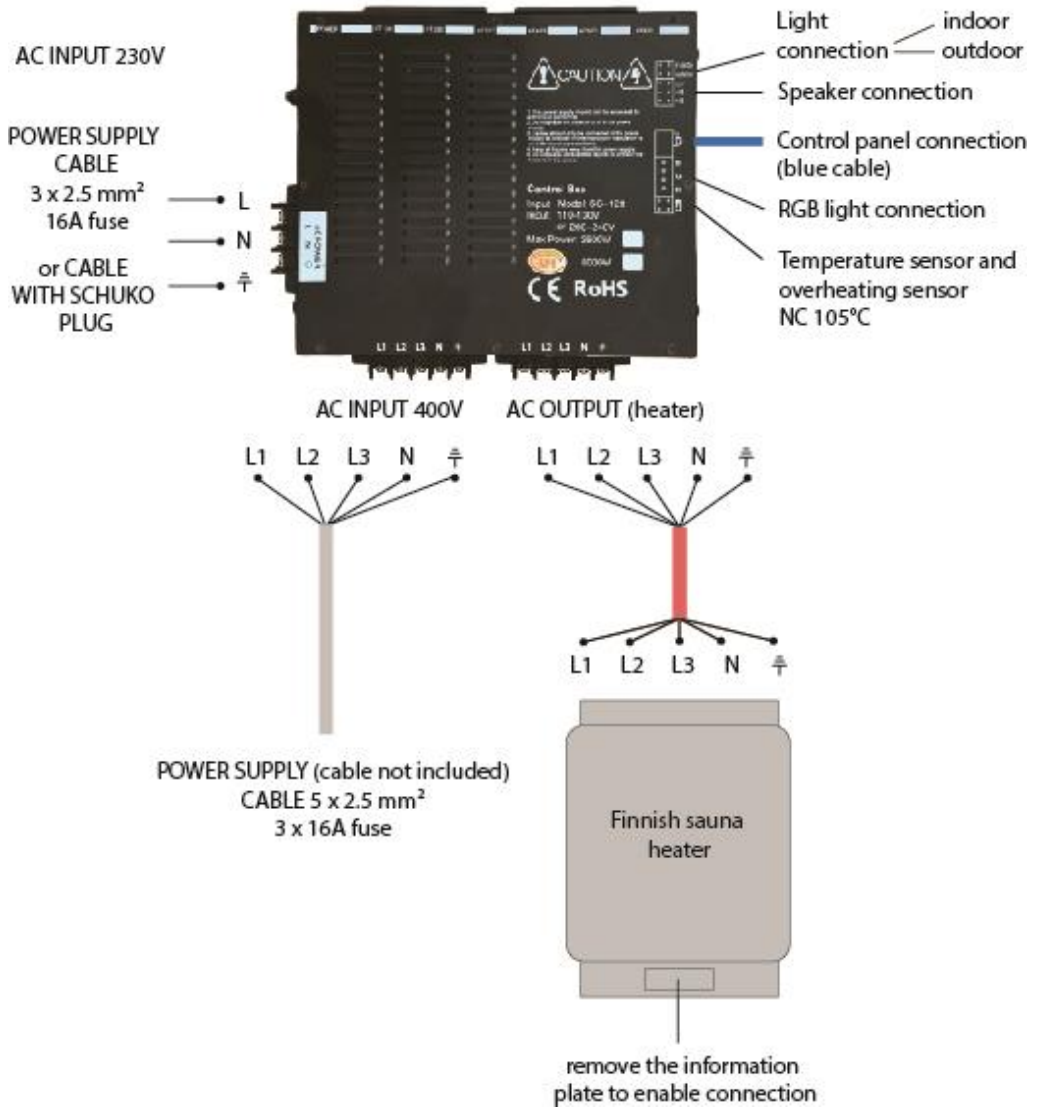

Zastopa in prodaja:

Jana Splet d.o.o.
Kolodvorska cesta 16a
1330 Kočevje
ID za DDV: SI26216477

Tel: +386 (0)70 700 805
Splet: www.jjspa.si
E-naslov: spa@jjjana.si

