



FINSKA SAVNA JK200

Specifikacije in navodila za sestavo

SLO

HR

EN



FINSKA SAVNA JK200

Specifikacije in navodila za sestavo

SLO

SPECIFIKACIJE

Model	JK200
Dimenzije	2000 x 2000 x 2005 mm
Število oseb	6
Les	Hemlock, 48 mm
Steklo	Prozorno, kaljeno, 8 mm
Tečaji	INOX
Upravljanje	Nadzorna plošča na dotik
Čas delovanja	Do 90 min
Temperatura	Do 90 °C
Prezračevanje	Da
Povezljivost	USB, Bluetooth, radio, aplikacija
Osvetlitev	LED RGB zvezdnato nebo
Peč	8 kW, s termostatom, časovnikom in vulkanskim kamenjem
Priklop	Trofazni: 400 V, 50 Hz vodnik 5 x 2,5 mm ² in 3 x 16 A varovalka
Teža	572 kg

SESTAVNI DELI

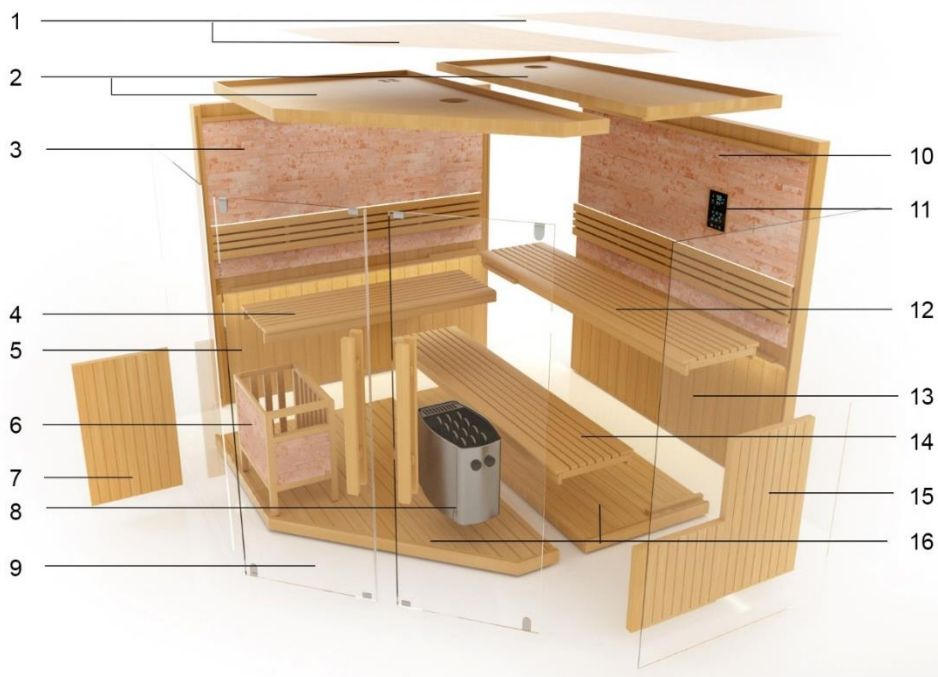

1 Pokrivni plošči*

2 Stropni plošča

3 Leva hrbtna zgornja plošča

4 Leva zgornja klop

5 Leva hrbtna spodnja plošča

6 Okvir peči

7 Leva nosilna stranica klopi

8 Peč

9 Stekla

10 Desna zgornja hrbtna plošča

11 Nadzorna plošča

12 Desna zgornja klop

13 Desna hrbtna spodnja plošča

14 Desna spodnja klop

15 Desna nosilna stranica klopi

16 Dno (2 dela)

*Novi modeli imajo pokrivne plošče z izrezi.

SESTAVA SAVNE

Priporočeno orodje

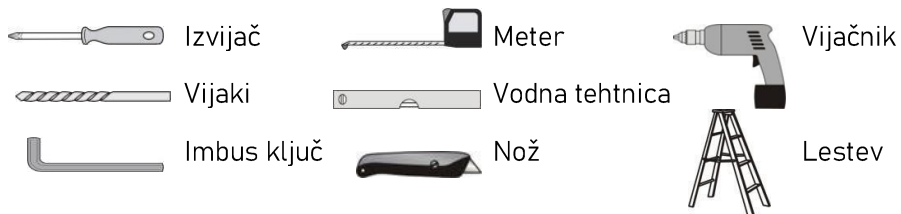

Nasveti za sestavo

Prosimo, odstranite transportno embalažo in preverite, ali je vaša savna dostavljena v celoti in nepoškodovana, preden začnete s sestavljanjem. Za sestavljanje savne so potrebne vsaj tri osebe.

Koraki sestave



1. Leva spodnja hrbtna plošča

2. Desna spodnja hrbtna plošča

3. Desna zgornja hrbtna plošča



4. Vtaknite kabel v spodnji hrbtni del.



5. Leva zgornja hrbtna plošča. Vtaknite kabel.



6. Stranske letve



7. Privijajte letve



8. Privijajte skupaj oba dela dna



9. Vstavite dno



10. Privijajte dno



11. Vstavite stekleni stranici



12. Stropna plošča 1



13. Stropna plošča 2

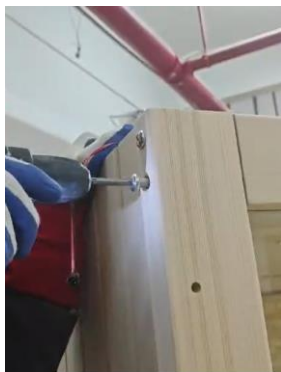

14. Privijačite stropni plošči s strani

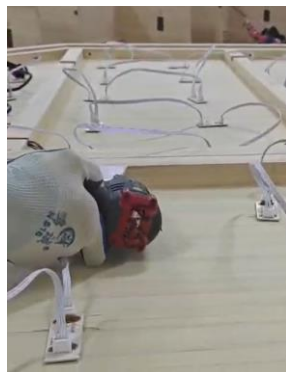

15. Privijačite stropni plošči med sabo in po robovih

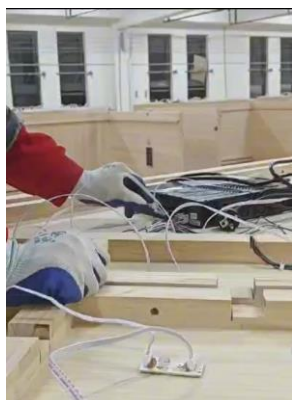

16. Povežite elektronske komponente (glejv nadaljevanju)



17. Desna nosilna stranica klopi



18. Leva nosilna stranica klopi



19. Desna zgornja klop



20. Leva zgornja klop



21. Privijačite nosilni strani, ko so klopina mestu.



22. Desna spodnja klop



23. Privijačite tečaje



24. Razprite tečaje, vstavite steklena vrata in zložite tečaje ter privijačite.



25. Ročaji



26. Pokrivna plošča



27. Peč in ogrodje peči

Zunanja zaponka

Stranice savne sestavite skupaj z zaponko na zunanji strani.

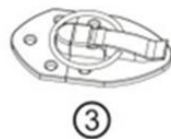
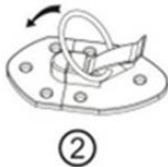
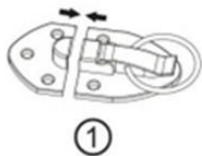

Priključitev električnih komponent



1. Priključite moder UTP kabel iz nadzorne plošče v nadzorno enoto savne.

2. Povežite kabel zvezdnatega neba v nadzorno enoto.



3. Povežite kable zvezdnatega neba



4. Spojite druge kable

* v primeru nejasnosti pokličite na telefonsko številko 070 700 805.

Namestitev tečajev, ročaja in pokrova



1. Namestite tečaje – mehka dela morata biti ob steklu, na notranjosti tečajev



2. Namestite ročaj, vijaki iz notranje strani savne.



3. Namestite pokrivno ploščo

SHEMA VEZAVE

AC VHOD
230V

NAPAJANJE
VODNIK
3 x 2,5 mm²
16A varovalka

ali KABEL Z
VTIKACEM
SCHUKO



AC VHOD 400V



NAPAJANJE (kabel ni priložen)
VODNIK 5 x 2,5 mm²
3 x 16A varovalka

AC IZHOD (peč)

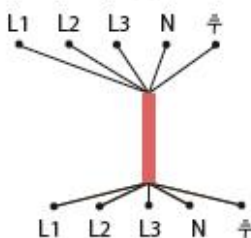

odstranite informacijsko
ploščico, da omogočite
priklop

FINSKA SAUNA JK200

Specifikacije i upute za montažu

HR

SPECIFIKACIJE

Model	JK200
Dimenzije	2000 x 2000 x 2005 mm
Broj osoba	6
Drvo	Hemlock, 48 mm
Staklo	Prozirno, kaljeno, 8 mm
Šarke	INOX
Upravljanje	Upravljačka ploča na dodir
Vrijeme rada	Do 90 min
Temperatura	Do 90 °C
Ventilacija	Da
Povezivost	USB, Bluetooth, radio, aplikacija
Rasvjeta	LED RGB zvjezdano nebo
Peć	8 kW, s termostatom, timerom i vulkanskim kamenom
Veza	Trofazni: 400 V, 50 Hz vodič 5 x 2,5 mm ² in 3 x 16 A osigurač
Težina	572 kg

SASTAVNI DJELOVI

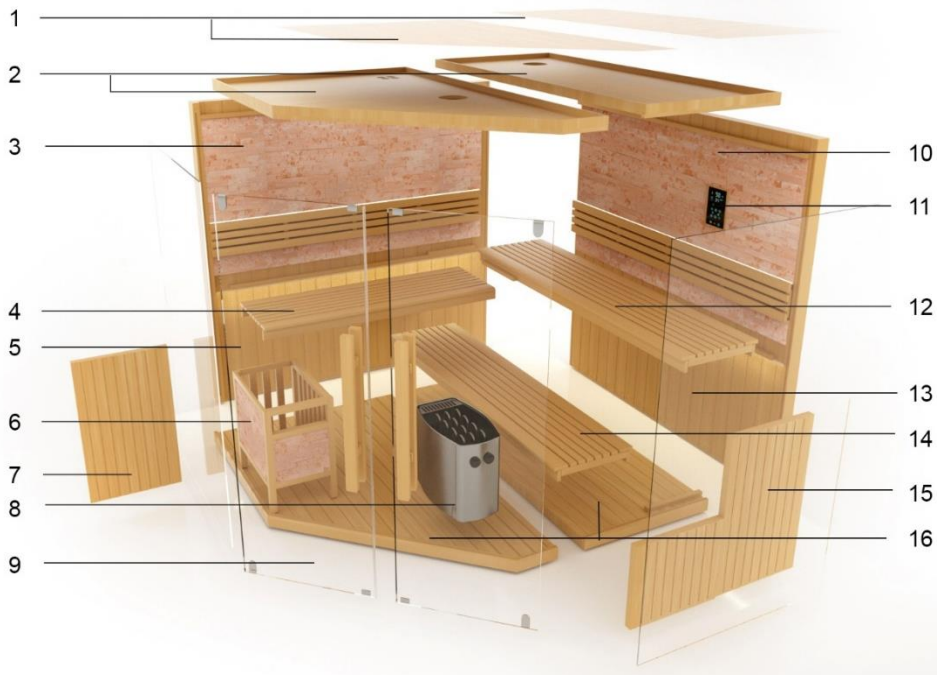

1 Pokrovne ploče*

2 Stropne ploče

3 Lijeva stražnja gornja ploča

4 Leva gornja klupa

5 Leva stražnja donja plošča

6 Okvir peći

7 Lijeva potporna strana klupe

8 Peć

9 Stakla

10 Desna gornja stražnja ploča

11 Kontrolna plošča

12 Desna gornja klupa

13 Desna donja stražnja ploča

14 Desna donja klupa

15 Desna potporna strana klupe

16 Dno 2x

*Novi modeli imaju pokrovne ploče s izrezima.

SASTAVA SAUNE

Priporučeni alati

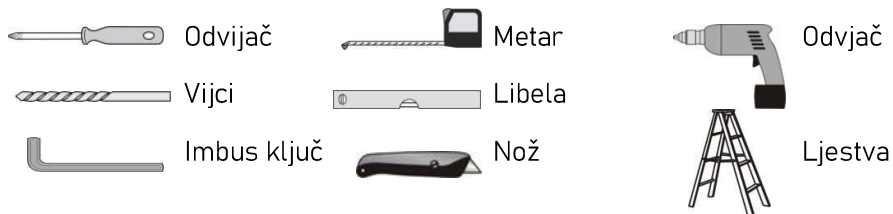

Savjeti za sastavljanje

Molimo Vas da uklonite ambalažu za otpremu i provjerite je li Vaša sauna isporučena potpuna i neoštećena prije početka sastavljanja. Za sastavljanje saune potrebne su najmanje tri osobe.

Koraci montaže



1. Lijeva donja stražnja ploča



2. Desna donja stražnja ploča



3. Desna gornja stražnja ploča



4. Utaknite kabel u donji dio leđa.



5. Lijeva gornja stražnja ploča. Utaknite kabel.



6. Bočne stranske letve

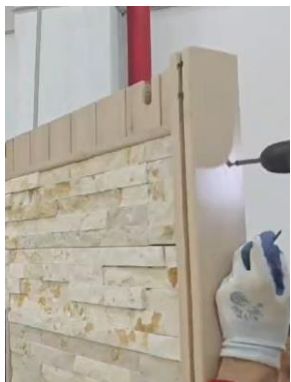

7. Zašrafite letve



8. Vijcima spojite oba dijela dna



9. Umetnite dno



10. Pričvrstite dno



11. Umetnite staklene strane



12. Stropna ploča 1



13. Stropna ploča 2

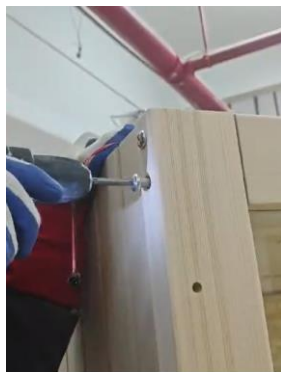

14. Vijcima pričvrstite stropnu ploču sa strane

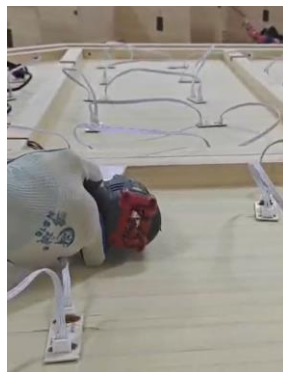

15. Vijcima pričvrstite stropne ploče zajedno i uzduž rubova



16. Spojite električne komponente (pogledajte dolje)



17. Desna nosiva strana klupe



18. Lijeva nosiva strana klupe



19. Desna gornja klupa



20. Lijeva gornja klupa



21. Vijcima pričvrstite potpurnu stranu kada su klupe na svom mjestu.



22. Desna donja klupa



23. Vijcima pričvrstite šarke



24. Otvorite šarke, umetnite staklena vrata i preklopite šarke i pričvrstite.



24. Ručke



26. Poklopna ploča



27. Peć i okvir peći

Vanjska kopča

Stranice saune sastavite zajedno pomoću kopče na vanjskoj strani.

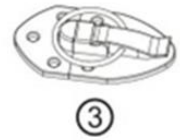
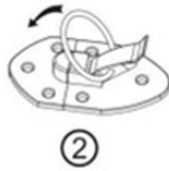
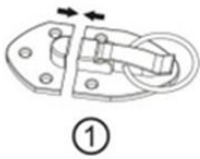

Spajanje električnih komponenti



1. Spojite plavi UTP kabel s upravljačke ploče na upravljačku jedinicu saune.

2. Spojite kabel zvjezdanog neba na upravljačku jedinicu.



3. Spojite kabele zvjezdanog neba



4. Spojite ostale kabele (zvučnike i upravljačku jedinicu)

* u slučaju nejasnoća nazovite +38670 700 805.

Ugradnja Šarki, ručke i poklopca



1. Instalirajte šarke - meki dijelovi moraju biti uz staklo, s unutarnje strane šarke



2. Postavite ručku, vijke s unutarnje strane saune.



3. Postavite pokrovnu ploču

SHEMA POVEZIVANJA

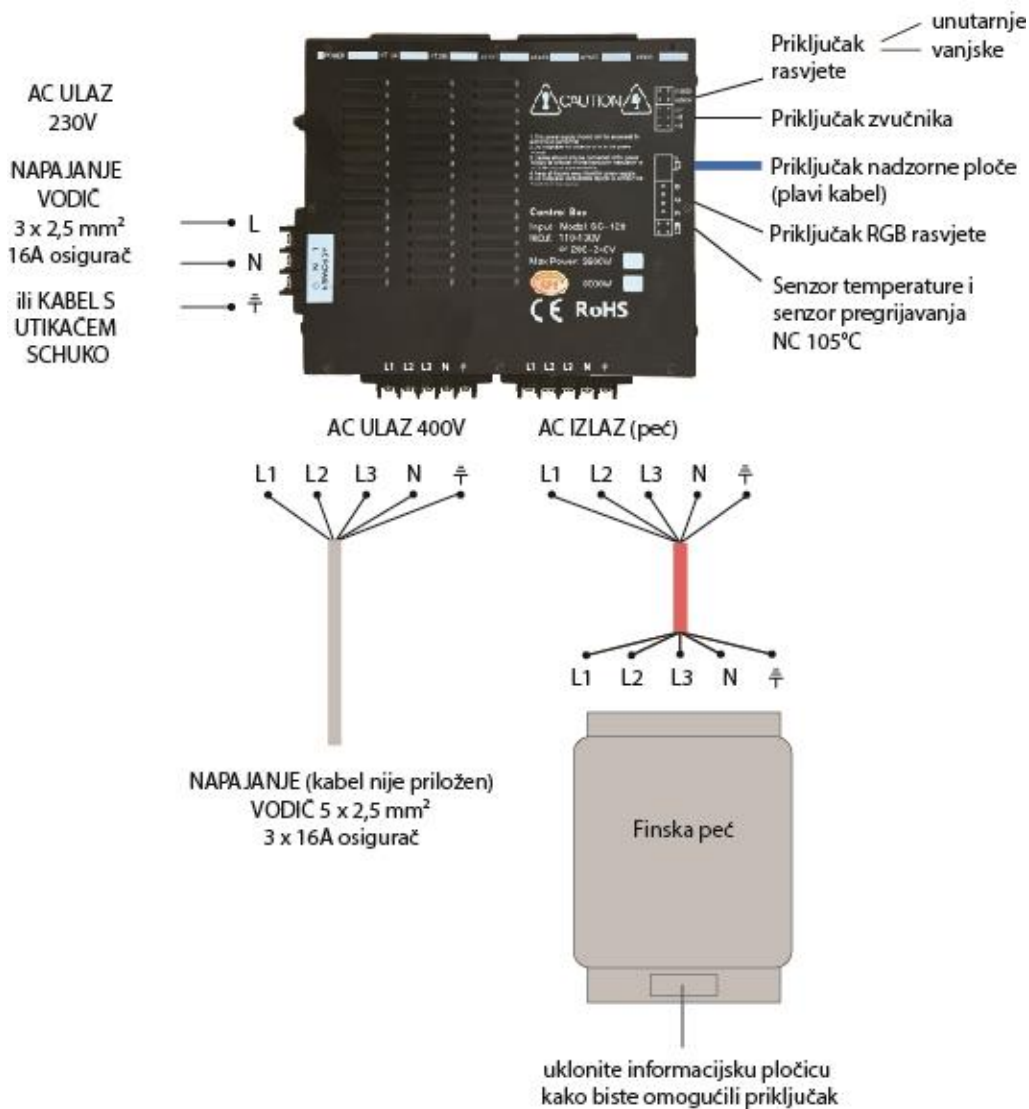

FINNISH SAUNA JK200

Specifications and assembly instructions

EN

SPECIFICATIONS

Model	JK200
Dimensions	2000x2000x2005 mm
Number of persons	6
Material	Hemlock, 48 mm, stone
Glass	Transparent, tempered, 8 mm
Hinges	Stainless Steel
Control	Touch ontrol panel
Operating time	Up to 90 min
Temperature	Up to 90 °C
Ventilation	Yes
Connectivity	USB, Bluetooth, Radio, App
Lighting	LED RGB starry sky
Stove	8 kW, with thermostat, timer and volcanic stone
Connection	Three-phase: 400 V, 50 Hz, or conductor 5 x 2,5 mm ² and 3 x 16 A fuse
Weight	572 kg

COMPONENTS

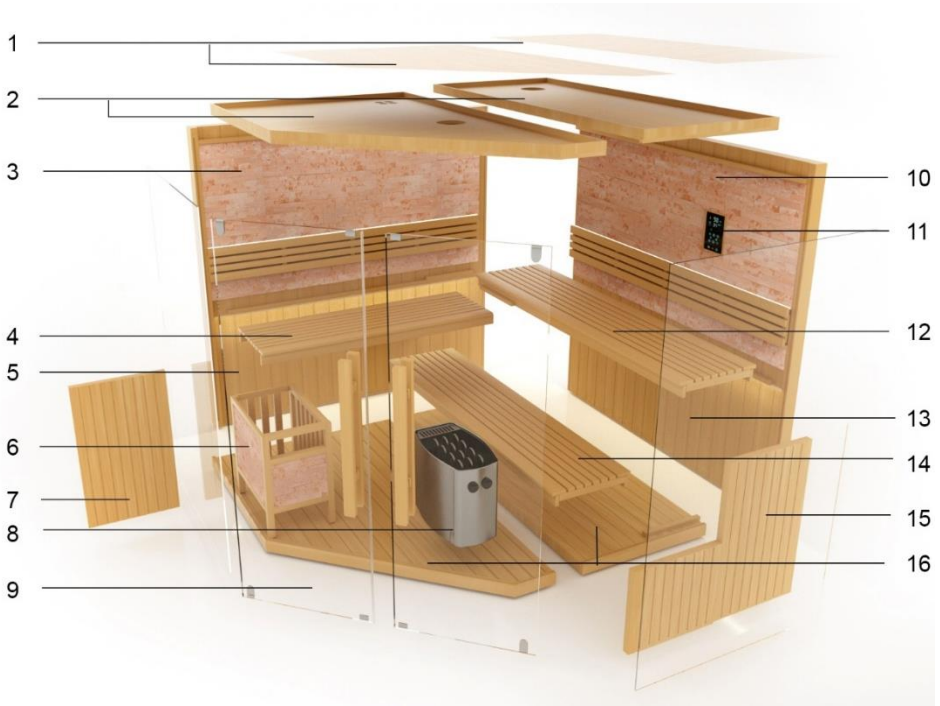

1 Cover plates*

2 Ceiling panel

3 Left upper back panel

4 Upper bench

5 Left lower back panel

6 Stove frame

7 Left bench support plate

8 Stove

9 Glass panels

10 Right upper back panel

11 Control panel

12 Right upper bench

13 Right lower back panel

14 Right lower bench

15 Right bench support plate

16 Floor

*New models have cover panels with cut-outs.

SAUNA ASSEMBLY

Recommended tools

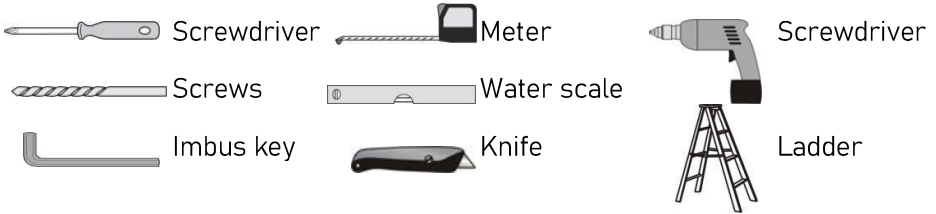

Assembly tips

Please remove the shipping packaging and verify that your sauna has been delivered complete and undamaged before beginning the assembly process. At least three people are required to assemble the sauna.

Assembly steps





4. Insert the cable into the lower back.



5. Left upper back panel. Insert the cable.



6. Side slats



7. Screw the slats



8. Screw both bottom parts together



9. Insert the bottom



10. Screw the bottom



11. Insert the glass side



12. Ceiling panel 1



12. Ceiling panel 2

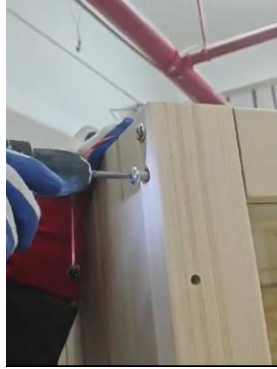

14. Screw the ceiling panel from the side

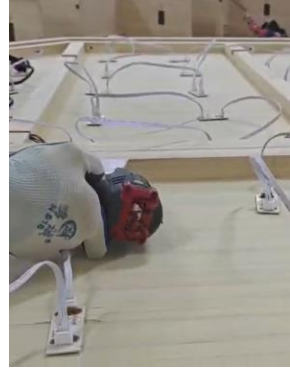

15. Screw the ceiling panels together and along the edges



16. Connect the electrical components (see below)



17. The right bearing side of the bench



18. The left bearing side of the bench



19. Right upper bench



20. Left upper bench



21. Screw the support side when the benches are in place.



22. Right lower bench



23. Screw the hinges



24. Open the hinges, insert the glass door and fold the hinges and fasten.



25. Handles



26. Cover plate



26. Finnish sauna heater

Outer buckle

Assemble the sauna sides together with the clasp on the outside.

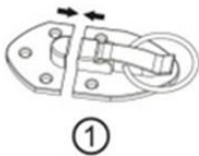

①

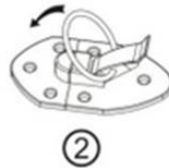

②

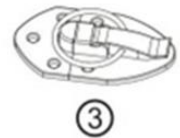

③

Connecting electrical components



1. Connect the blue UTP cable from the control panel to the sauna control unit.

2. Connect the starry sky cable to the control unit.



3. Connect the starry sky cables

4. Connect other cables (speakers and control unit)

* in case of ambiguity, call +38670 700 805.

Installation of hinges and handle



1. Install the hinges - the soft parts must be next to the glass, on the inside of the hinges

2. Install the handle, screws from the inside of the sauna.

3. Install the cover plate

WIRING DIAGRAM

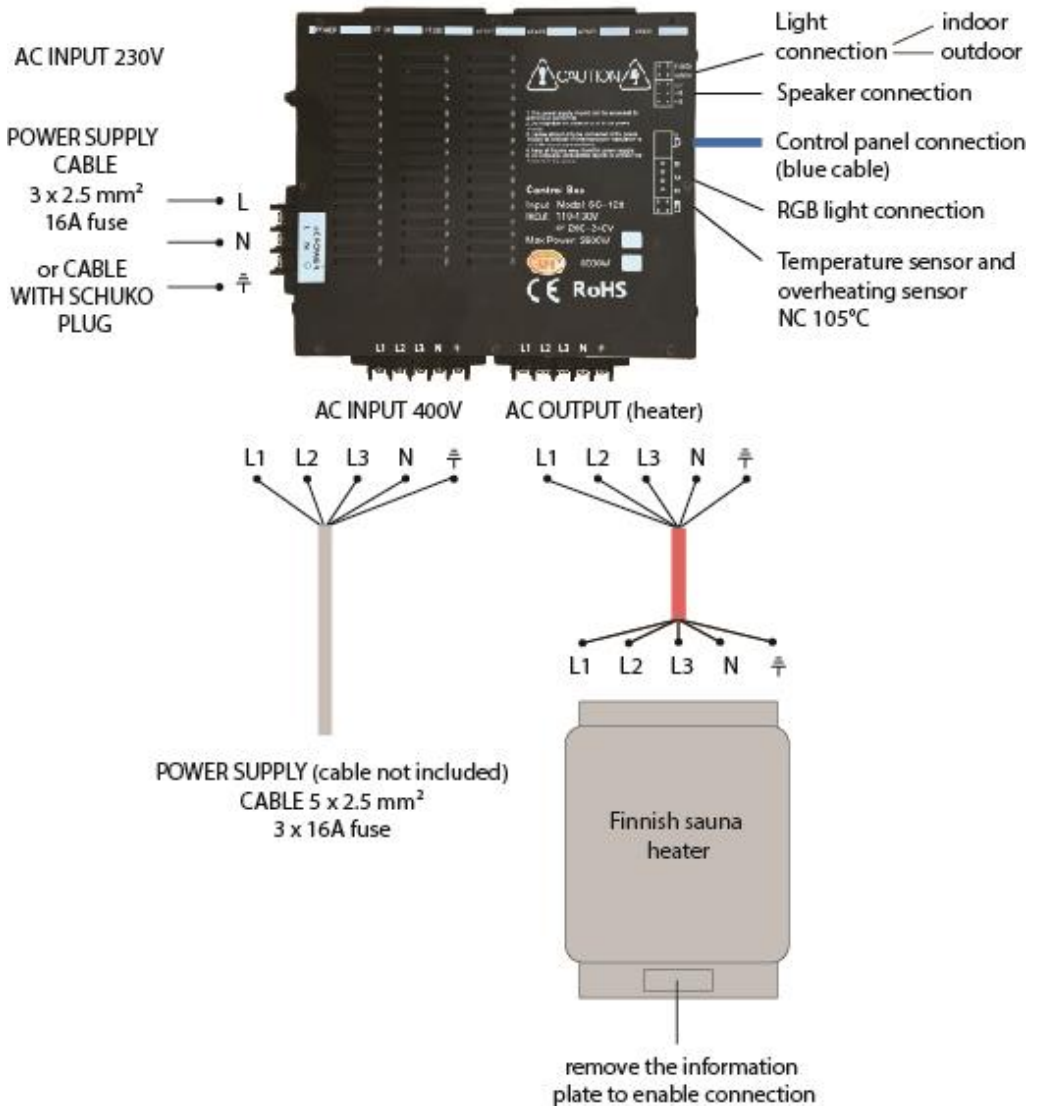

Zastopa in prodaja:

Jana Splet d.o.o.
Kolodvorska cesta 16a
1330 Kočevje
ID za DDV: SI26216477

Tel: +386 (0)70 700 805
Splet: www.jjspa.si
E-naslov: spa@jjana.si

